

管道类工具

Plumbing Tools

管子钳	89-91
链条扳手	91
鹰嘴钳	92
水泵钳	92-93
管子割刀及刀片	94
Pipe Wrench	89-91
Chain Pipe Wrench	91
Swedish Type Pipe Wrench	92
Box Joint Pliers	92-93
Pipe Cutter and replaced blades	94



管道焊接定位器 Pipe Welding Clamp

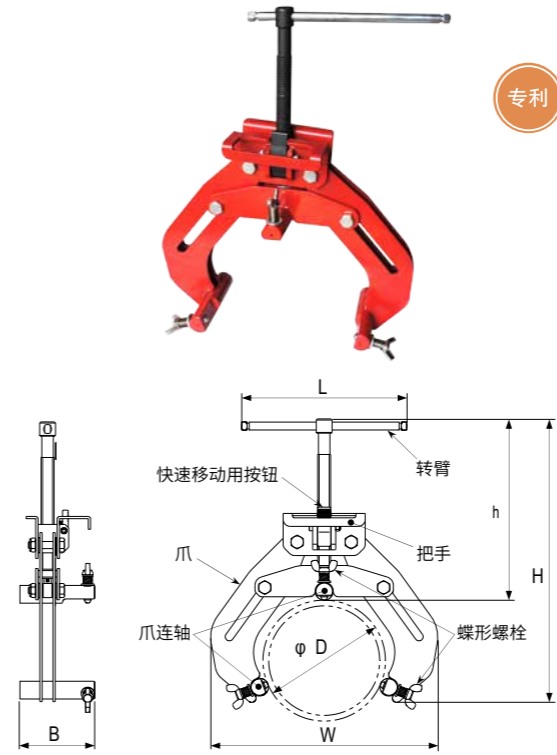

货号 Item No	规格 Size	D(mm)	B(mm)	W(mm)	H(mm)	h(mm)	L(mm)	单支重 NW/PC	装箱数 Po/Carton
M 37921	1~6B	34~170	105	219~335	314~403	255	230	5.11kg	4pcs
M 37920	4~12B	110~320	105	348~525	448~568	322	230	7.86kg	2pcs

• 专利产品 适用于管道连接焊接时的准确定位和夹紧
 • Patented design Suitable for accurate positioning and clamping in pipe welding.

超强力级工业级管子钳 Heavy Duty Pipe Wrench



货号 Item No	规格 Size	总长 length	夹持直径 Clamping Dia.	装盒数 Po/Box	装箱数 Po/Carton	毛重 GW/CTN	单支重 NW/PC
M 37171	200mm(8')	210mm	27mm	1pc	48pcs	19.70kg	0.35kg
M 37172	250mm(10')	275mm	33mm	1pc	24pcs	19.20kg	0.73kg
M 37173	300mm(12')	328mm	42mm	1pc	16pcs	19.60kg	1.18kg
M 37174	350mm(14')	370mm	48mm	1pc	12pcs	20.20kg	1.65kg
M 37175	450mm(18')	465mm	60mm	1pc	8pcs	21.20kg	2.53kg
M 37176	600mm(24')	627mm	73mm	1pc	6pcs	24.90kg	3.97kg
M 37178	900mm(36')	890mm	102mm	1pc	2pcs	18.50kg	8.89kg
M 37179	1200mm(48')	1200mm	141mm	1pc	2pcs	33.00kg	16.17kg

• 总长是指产品处于夹持标准试棒的长度。
 • 钳体是用球墨铸铁铸造而成，强度大且韧性好
 • 圆形手柄末端，可以防止管钳意外滑落
 • 手柄末端孔型结构便于悬挂
 • 活动钳口采用Cr-Mo材质，经过特殊热处理，既保证经久强度又提高了韧性
 • 扭矩超美标 50% 以上
 • Overall length is the length of tools clamp the standard mandrel.
 • Ductile cast iron handle, strong strength and good toughness
 • Special heat treatment with the Cr-Mo hook jaw, ensure the strength and improve toughness
 • Torque exceed ANSI standard 50%

超强力级快速管子钳 Quick Adjust Pipe Wrench



货号 Item No	规格 Size	夹持直径 Clamping Dia.	L (总长) length	装盒数 Po/Box	装箱数 Po/Carton	毛重 GW/CTN	单支重 NW/PC
M 37328	250mm(10')	38mm	250mm	1pc	24pcs	22.80kg	0.88kg
M 37329	350mm(14')	54mm	350mm	1pc	12pcs	23.00kg	1.79kg

• 专利产品 ZL200430089372.3, ZL200420098741.X
 • 总长是产品处于夹持直径状态的长度
 • 球墨铸造柄，黑色磷化活动钳口
 • 特殊的钳口设计，使其可快速的夹紧管件
 • Patent products ZL200430089372.3, ZL200420098741.X
 • The full length is the length of the tools in Max. working Dia.
 • Ductile cast iron handle, strong strength and good toughness
 • Special jaw design allows fast clamping to the pipe.

管式大开口扳手 Pipe Wrench Type End Adjustable Wrench



货号 Item No	规格 Size	夹持直径 Clamping Dia.	L (总长) length	装盒数 Po/Box	装箱数 Po/Carton	毛重 GW/CTN	单支重 NW/PC
M37401	300mm(12')	29-67mm	278mm	1pc	20pcs	16.60kg	0.78kg

• 六角钳口设计，能够牢固的抓紧所有六角螺母、方螺母、活接头和阀门盘根螺母上的多个面
 • 超宽开口斜管钳型号，是固定水槽和浴盆上下水管螺母的理想选择
 • 平顺的薄钳口设计，可滑进极小空间，适合狭小空间使用
 • The hexagonal jaw design can firmly grasp all the hexagonal nuts, square nuts, unions and multiple surfaces on the valve disc and nut.
 • The super wide opening diagonal pipe wrench design is an ideal choice for fixing the upper and lower pipe nuts of sinks and bathtubs.
 • The smooth and thin jaw design can slide into a very small and wall-based space, suitable for use in tight spaces.

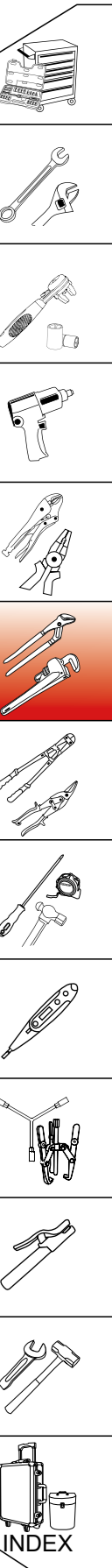

INDEX

超强力级铝柄管子钳

Heavy Duty Aluminum Pipe Wrench

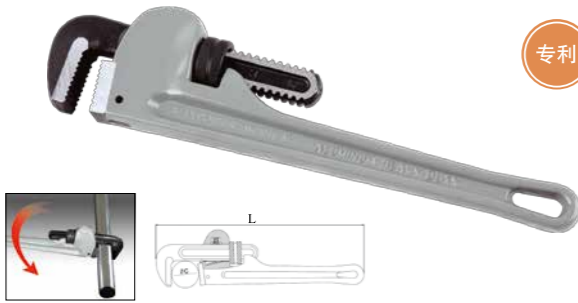

专利

货号 Item No	规格 Size	L(总长) length	夹持直径 Clamping Dia.	装盒数 Pc/Box	装箱数 Pc/ Carton	毛重 GW/CTN	单支重 NW/PC
M 37088	200mm(8")	200mm	27mm	1pc	48pcs	12.10kg	0.22kg
M 37089	250mm(10")	275mm	33mm	1pc	36pcs	18.40kg	0.45kg
M 37090	300mm(12")	328mm	42mm	1pc	24pcs	17.40kg	0.65kg
M 37091	350mm(14")	369mm	48mm	1pc	12pcs	11.56kg	0.84kg
M 37092	450mm(18")	465mm	60mm	1pc	12pcs	18.00kg	1.49kg
M 37093	600mm(24")	623mm	73mm	1pc	6pcs	14.60kg	2.46kg
M 37095	900mm(36")	920mm	102mm	1pc	4pcs	17.50kg	4.50kg
M 37096	1200mm(48")	1200mm	141mm	1pc	2pcs	17.00kg	8.05kg

- 专利产品 ZL200330109828.3
- 总长是指产品处于夹持直径状态的长度，活动钳口采用Cr-Mo材质
- 钳口经过特殊的热处理，保证经久耐用，可以快速方便的咬紧管子，重量比同规格的普通管子钳轻 30% 以上
- 性能超美标 30% 以上
- Patent products ZL200330109828.3
- The full length is the length of the tools in Max. working Dia.
- Special heat treatment with the Cr-Mo hook jaw, ensure the strength and improve toughness
- Performance exceed ANSI standard more than 30%

英式锻造管子钳

Stillson type pipe wrench



货号 Item No	规格 Size	L(总长) length	夹持直径 Clamping Dia.	装盒数 Pc/Box	装箱数 Pc/ Carton	单支重 NW/PC	毛重 GW/CTN
M 37193	250mm(10")	250mm	33mm	2pcs	36pcs	0.46kg	17.70kg
M 37194	300mm(12")	305mm	42mm	2pcs	24pcs	0.67kg	17.20kg
M 37195	350mm(14")	350mm	48mm	2pcs	12pcs	0.97kg	12.40kg
M 37196	450mm(18")	450mm	60mm	2pcs	12pcs	1.52kg	19.20kg
M 37197	600mm(24")	600mm	73mm	1pc	6pcs	2.48kg	16.10kg
M 37199	900mm(36")	885mm	102mm	1pc	4pcs	4.82kg	20.50kg

- 钳体采用45#优质碳素钢锻压而成，整支热处理
- 钳头采用优质钢锻造，经过多次热处理，齿部硬度达到HRC56-60
- 强度超美国国家标准
- 工作携带轻便
- 使用安全 钳体不断裂
- 45# drop forged body, heat treated
- Jaws made of high quality steel, drop forged and heat treated, teeth hardness up to HRC 56-60
- Torque exceed ANSI standard
- Easy to carry
- Safe to use, the body won't break

强力级管子钳

Heavy Duty Pipe Wrench



货号 Item No	规格 Size	L(总长) length	夹持直径 Clamping Dia.	装盒数 Pc/Box	装箱数 Pc/ Carton	毛重 GW/CTN	单支重 NW/PC
M 37110	150mm(6")	150mm	21mm	6pcs	72pcs	17.80kg	0.24kg
M 37111	200mm(8")	200mm	27mm	1pc	48pcs	19.70kg	0.38kg
M 37112	250mm(10")	260mm	33mm	1pc	36pcs	25.80kg	0.67kg
M 37113	300mm(12")	300mm	42mm	1pc	24pcs	23.70kg	0.93kg
M 37114	350mm(14")	350mm	48mm	1pc	12pcs	15.50kg	1.20kg
M 37115	450mm(18")	450mm	60mm	1pc	12pcs	25.70kg	2.02kg
M 37116	600mm(24")	600mm	73mm	1pc	6pcs	19.80kg	3.11kg
M 37118	900mm(36")	900mm	102mm	1pc	4pcs	25.20kg	5.94kg
M 37119	1200mm(48")	1200mm	141mm	1pc	2pcs	29.30kg	13.98kg

- 总长是指产品处于夹持直径状态的长度
- 钳体是用球墨铸铁铸造而成，强度大且韧性好
- 圆形手柄末端，可以防止管钳意外滑落
- 手柄末端孔型结构便于悬挂
- 活动钳口采用Cr-Mo材质，经过特殊热处理，既保证经久强度又提高了韧性
- 扭矩超美标 50% 以上
- The full length is the length of the tools in Max. working Dia.
- Ductile cast iron handle, strong strength and good toughness
- Special heat treatment with the Cr-Mo hook jaw, ensure the strength and improve toughness
- Torque exceed ANSI standard 50%

搭配使用零部件

重型管子钳活动钳口

Movable Jaw for heavy duty pipe wrench

货号 Item No	规格 Size	装箱数 Pc/ Carton
M 98213	300mm(12")	60pcs
M 98214	350mm(14")	40pcs
M 98215	450mm(18")	30pcs
M 98216	600mm(24")	18pcs
M 98218	900mm(36")	12pcs
M 98219	1200mm(48")	6pcs

重型管子钳调节螺母

Nut for heavy duty pipe wrench

货号 Item No	规格 Size	装箱数 Pc/ Carton
M 98233	300mm(12")	240pcs
M 98234	350mm(14")	200pcs
M 98235	450mm(18")	140pcs
M 98236	600mm(24")	120pcs
M 98238	900mm(36")	72pcs
M 98239	1200mm(48")	40pcs

重型管子钳固定钳口(带销)

Fixed Jaw for heavy duty pipe wrench

货号 Item No	规格 Size	装箱数 Pc/ Carton
M 98223	300mm(12")	320pcs
M 98224	350mm(14")	280pcs
M 98225	450mm(18")	200pcs
M 98226	600mm(24")	140pcs
M 98228	900mm(36")	80pcs
M 98229	1200mm(48")	60pcs

△ 本品属于易耗品，不属于终身保用范围
△ No warranty as consumables

加力管子钳

Pipe Wrench With Reinforcing Bar



手柄可伸缩加力

货号 Item No	规格 Size	夹持直径(MAX) Clamping Dia.(MAX)	夹持标准直径长度(缩进/伸开) Clamping standard diameter length(retract/extend)	装盒数 Pc/Box	装箱数 Pc/ Carton	毛重 GW/CTN	单支重 NW/PC
M 37373	80D	95mm	525mm / 680mm	1pc	6pcs	19.00kg	2.88kg
M 37374	108D	110mm	708mm / 973mm	1pc	4pcs	25.00kg	5.44kg
M 37375	132D	140mm	846mm / 1230mm	1pc	2pcs	16.00kg	6.86kg
M 37377	195D	195mm	973mm / 1361mm	1pc	2pcs	21.00kg	9.25kg

- 钳头采用铬钼钢锻造，经过多次热处理
- 钳体采用CRV无缝钢管热处理，硬度HRC40-50
- 使用加长杆更省力、快捷
- The jaws made of high quality drop forged Cr-Mo steel, heat-treated
- The body is made of CRV seamless steel pipe, heat-treated, hardness HRC40-50
- The extended handle save power and make work easier

轻便型快速管子钳

Quick Adjust Pipe Wrench



尾部可以当撬杠使用

货号 Item No	规格 Size	L(总长) length	夹持直径 Clamping Dia.	装盒数 Pc/Box	装箱数 Pc/ Carton	单支重 NW/PC	毛重 GW/CTN
M 37315	200mm(8")	260mm	14-27mm	6pcs	36pcs	0.33kg	13.40kg
M 37316	350mm(14")	380mm	27-63mm	6pcs	24pcs	0.60kg	23.00kg

- 整体60#优质碳素钢锻压，整支热处理，齿部高频HRC55-60
- 新型设计，结构简单，不用调节螺母，可单手操作
- 重量轻，夹持范围较大，使用方便，调节速度快
- 尾部可以当撬杠使用
- Whole body 60# drop forged, heat treated, carbon steel teeth high frequency quenched, HRC 55-60
- New design, simple structure, one hand operation, no need to adjust screw
- Light type with wider clamping capacity, easy to use, quick adjustment
- End can be used as crowbar

链条扳手

Chain Wrench



货号 Item No	规格 Size	L length	链条长度 Chain length	装盒数 Pc/ Carton	毛重 GW/CTN	单支重 NW/PC
M 37438	300mm(12")	308mm	381mm	24pcs	21.50kg	0.85kg
M 37439	375mm(15")	380mm	460mm	16pcs	19.00kg	1.13kg
M 37440	600mm(24")	615mm	539mm	12pcs	19.20kg	1.58kg

- 整支铬钼钢锻造而成，齿部特殊热处理
- 可拆卸汽车滤芯，管道安装等，可夹持不同形状的物体
- 链条通过两个支点保障把手安全，便于在受限的狭小空间使用
- Drop forged with CRV, special heat treatment with the jaw
- Can be used in special area and irregular objects



链条扳手使用方法：根据物体直径选择适宜的链条长度，将链条捆绑在物体上，即可将物体扳拧。

The operating instruction of chain wrench: choose the appropriate chain length according to the diameter of object, bind the chain to the object and then tighten or loosen.

链条管子钳

Chain Pipe Wrench

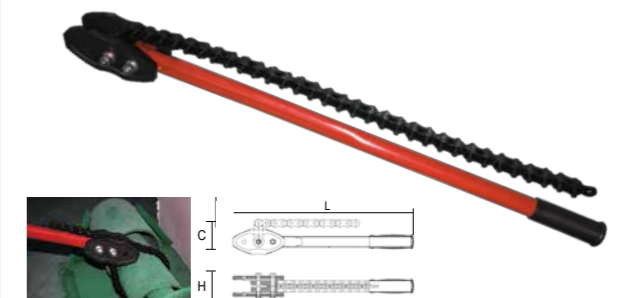

货号 Item No	夹持规格 Size	长度 L(mm)	宽度 C(mm)	高度 H(mm)	链条长度 Chain length	装盒数 Pc/Box	装箱数 Pc/ Carton	毛重 GW/CTN	单支重 NW/PC
M 37457	100mm(4")	890mm	93mm	80mm	660mm	1pc	3pcs	20.50kg	6.332kg
M 37458	150mm(6")	1000mm	93mm	90mm	812mm	1pc	2pcs	16.50kg	7.510kg
M 37459	200mm(8")	1200mm	93mm	95mm	965mm	1pc	2pcs	19.00kg	9.013kg

- 钳口采用优质合金钢精密铸造而成，经过整体热处理和齿部高频，具有不磨损，不打滑，使用寿命长等优点；
- 用于管道安装等，可夹持大口径管道和不同形状的物体。
- The jaws are precisely casted with high quality alloy steel. The whole body is heat-treated and the teeth goes through high frequency heat-treatment. The jaws can resist abrasion and slipping, which makes the product have a long lifetime.
- The product can be used for assembling the pipes and clamping objects with different diameters.

工业级 45° 弧嘴鹰嘴钳
Swedish Pipe Wrench-45° Type



工业级
CR-V

货号 Item No	规格 Size	L(总长) length	夹持直径 Clamping Dia.	装盒数 Pc/Box	装箱数 Pc/Carton	毛重 GW/CTN	单支重 NW/PC
M 37647	0.5"	235mm	39mm	1pc	48pcs	22.00kg	0.400kg
M 37648	1"	330mm	58mm	1pc	24pcs	20.00kg	0.770kg
M 37649	1.5"	415mm	85mm	1pc	16pcs	23.20kg	1.360kg
M 37650	2"	535mm	95mm	1pc	8pcs	19.60kg	2.300kg
M 37651	3"	652mm	106mm	1pc	6pcs	26.50kg	4.000kg

- 钳体铬钒钢锻造通过德国 VPA/GS 认证
- 45° 弧嘴设计, 夹持有力
- 适合狭小空间的管子夹持工作
- 瑞典式管钳, 使用轻便, 可代替各种钳类工具
- 寿命强度超过德国标准的 1 倍以上
- Drop forged with CRV, VPA/GS approval
- Special heat treatment with the jaw · 45° cured jaw design
- Swedish pipe wrench easy to be used, and can replace several kinds of pliers
- The using life can be one time longer than German standard

工业级 S 形鹰嘴钳
Swedish Pipe Wrench-S Type



工业级
CR-V

货号 Item No	规格 Size	L(总长) length	夹持直径 Clamping Dia.	装盒数 Pc/Box	装箱数 Pc/Carton	毛重 GW/CTN	单支重 NW/PC
M 37663	0.5"	235mm	38mm	1pc	48pcs	20.80kg	0.400kg
M 37664	1"	330mm	52mm	1pc	24pcs	20.90kg	0.800kg
M 37665	1.5"	420mm	74mm	1pc	16pcs	23.00kg	1.350kg
M 37666	2"	535mm	82mm	1pc	8pcs	21.50kg	2.400kg
M 37667	3"	652mm	128mm	1pc	6pcs	26.20kg	4.200kg

- 钳体铬钒钢锻造通过德国 VPA/GS 认证
- 钳口 S 型设计, 夹持更强劲
- 适合狭小空间的管子夹持工作
- 瑞典式管钳, 使用轻便, 可代替各种钳类工具
- 寿命强度超过德国标准的 1 倍以上
- Drop forged with CRV, VPA/GS approval
- S type jaw, clamping fasterly
- Swedish pipe wrench easy to be used, and can replace several kinds of pliers
- The using life can be one time longer than German standard

工业级 90° 鹰嘴钳
Swedish Pipe Wrench-90° Type

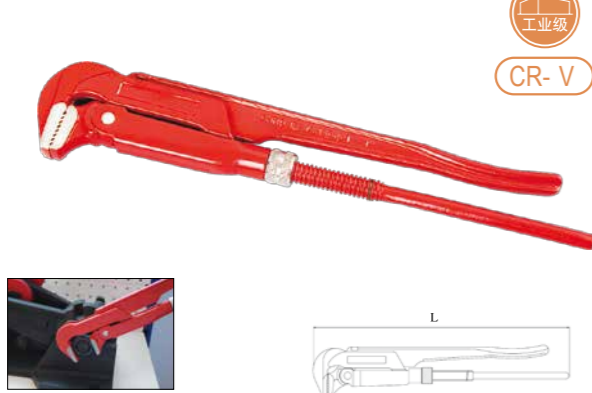

工业级
CR-V

货号 Item No	规格 Size	L(总长) length	夹持直径 Clamping Dia.	装盒数 Pc/Box	装箱数 Pc/Carton	毛重 GW/CTN	单支重 NW/PC
M 37631	1"	320mm	40mm	1pc	24pcs	18.20kg	0.700kg
M 37632	1.5"	425mm	62mm	1pc	16pcs	22.20kg	1.300kg
M 37633	2"	560mm	71mm	1pc	8pcs	18.80kg	2.200kg
M 37634	3"	630mm	103mm	1pc	6pcs	20.50kg	3.000kg
M 37635	4"	735mm	121mm	1pc	3pcs	17.50kg	5.200kg

- 钳体铬钒钢锻造通过德国 VPA/GS 认证
- 钳口经过特殊热处理
- 适合狭小空间的管子夹持工作
- 瑞典式管钳, 使用轻便, 可代替各种钳类工具
- 寿命强度超过德国标准的 1 倍以上
- Drop forged with CRV, VPA/GS approval
- Special heat treatment with the jaw
- Swedish pipe wrench easy to be used, and can replace several kinds of pliers
- The using life can be one time longer than German standard

工业级沾塑柄水泵钳
Box Joint Pliers



工业级
CR-V

货号 Item No	规格 Size	L(总长) length	夹持直径 Clamping Dia.	装盒数 Pc/Box	装箱数 Pc/Carton	毛重 GW/CTN	单支重 NW/PC
M 29553	250mm(10")	240mm	33mm	6pcs	48pcs	20.00kg	0.38kg
M 29554	300mm(12")	300mm	42mm	6pcs	36pcs	20.50kg	0.52kg

- 铬钒钢整体锻造, 特殊热处理
- 钳口特殊热处理
- 寿命超过普通产品的 5 倍以上
- 性能超过世界先进水平
- 通过德国 VPA/GS 认证
- 手柄浸塑处理, 握紧手柄夹持工件更舒适
- Drop forged with CRV, special heat treatment with body
- Special heat treatment with the jaw
- Using life can be 5 times longer than common products
- VPA/GS approval
- The dipped plastic handle makes gripping comfortable.

工业级水泵钳
Box Joint Pliers



工业级
CR-V

货号 Item No	规格 Size	L(总长) length	夹持直径 Clamping Dia.	装盒数 Pc/Box	装箱数 Pc/Carton	毛重 GW/CTN	单支重 NW/PC
M 29515	175mm(7")	173mm	24.5mm	6pcs	60pcs	11.00kg	0.180kg
M 29516	250mm(10")	240mm	33mm	6pcs	48pcs	19.60kg	0.380kg
M 29517	300mm(12")	300mm	42mm	6pcs	36pcs	21.00kg	0.570kg

- 铬钒钢整体锻造, 特殊热处理
- 钳口特殊热处理
- 寿命超过普通产品的 5 倍以上
- 性能超过世界先进水平
- 通过德国 VPA/GS 认证
- Drop forged with CRV
- Special heat treatment with the jaw
- Using life can be 5 times longer than common products
- VPA/GS approval

多功能水泵钳
Multifunction Water Pump Pliers



工业级
CR-V

货号 Item No	规格 Size	L(总长) length	夹持直径 Clamping Dia.	装盒数 Pc/Box	装箱数 Pc/Carton	毛重 GW/CTN	单支重 NW/PC
M 29524	250mm(10")	250mm	38mm	6pcs	48pcs	19.50kg	0.380kg

- 带一字螺丝批功能
- 铬钒钢整体锻造, 特殊热处理
- 钳口特殊热处理
- 寿命超过普通产品的 5 倍以上
- 性能超过世界先进水平
- 通过德国 VPA/GS 认证
- With function of slotted screwdriver
- Drop forged with CRV, special heat treatment with body
- Special heat treatment with the jaw
- Using life can be 5 times longer than common products
- VPA/GS approval

工业级自调水泵钳
Automatic Box Joint Pliers



专利
工业级
CR-V

货号 Item No	规格 Size	L(总长) length	夹持直径 Clamping Dia.	装盒数 Pc/Box	装箱数 Pc/Carton	毛重 GW/CTN	单支重 NW/PC
M 29573	175mm(7")	174mm	25mm	6pcs	120pcs	24.46kg	0.160kg
M 29574	250mm(10")	240mm	35mm	6pcs	60pcs	23.20kg	0.360kg
M 29575	300mm(12")	300mm	40mm	6pcs	36pcs	22.86kg	0.560kg

- 专利产品: ZL200720026951.1
- 铬钒钢整体锻造, 特殊热处理
- 快速调整间隙, 自动咬合工件, 操作舒适简便
- Patent products ZL200720026951.1
- Drop forged with CRV, Heat Treatment
- Quickly adjust, one hand operate

美式重型水泵钳
Straight Jaws Groove Joint Pliers



CR-V

货号 Item No	规格 Size	L(总长) length	夹持直径 Clamping Dia.	装盒数 Pc/Box	装箱数 Pc/Carton	毛重 GW/CTN	单支重 NW/PC
a.M 29590	200mm(8")	203mm	27mm	6pcs	60pcs	21.8kg	0.33kg
b.M 29597	250mm(10")	257mm	50mm	6pcs	36pcs	17.8kg	0.46kg
b.M 29598	300mm(12")	303mm	60mm	6pcs	36pcs	24.0kg	0.62kg
b.M 29599	400mm(16")	418mm	95mm	4pcs	16pcs	20.5kg	1.22kg

- 铬钒钢整体锻造, 特殊热处理
- 钳口经过两次特殊热处理
- 寿命超过普通产品的 5 倍以上
- 性能超过世界先进水平
- 通过德国 VPA/GS 认证
- Drop forged with CRV, special heat treatment with body and jaw
- Special heat treatment with the jaw
- Using life can be 5 times longer than common products
- VPA/GS approval
- 钳体表面无色电泳处理
- 手柄浸塑处理, 握持更舒适

锤头水泵钳
Groove Joint Pliers With Hammer Function

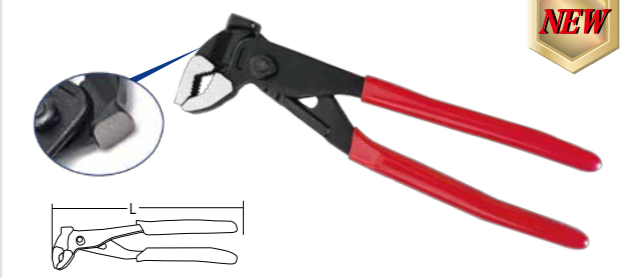

NEW

货号 Item No	规格 Size	L(总长) length	夹持直径 Clamping Dia.	装盒数 Pc/Box	装箱数 Pc/Carton	毛重 GW/CTN	单支重 NW/PC
M29550	250mm(10")	240mm	30mm	6pcs	60pcs	23.80kg	0.38kg

- 头部带锤头功能
- 钳口特殊热处理
- It has hammer function on the head
- Special heat treatment with the jaw

快调水泵钳
Groove Joint Pliers With Quick Release



NEW

货号 Item No	规格 Size	L(总长) length	夹持直径 Clamping Dia.	装盒数 Pc/Box	装箱数 Pc/Carton	毛重 GW/CTN	单支重 NW/PC
M29581	175mm(7")	163mm	25mm	6pcs	120pcs	29.80kg	0.24kg
M29582	250mm(10")	240mm	30mm	6pcs	60pcs	22.60kg	0.36kg
M29583	300mm(12")	310mm	40mm	6pcs	36pcs	18.04kg	0.71kg

- 快速调整间隙, 操作舒适简便
- Quickly adjust, one hand operate



金属管子割刀
Metal Pipe Cutter



适用于切割直径6-64mm之间的铜管、铝管和薄壁导管

货号 Item No	规格 Size	装盒数 Pc/Box	装箱数 Pc/Cartron	毛重 GW/CTN	单支重 NW/PC
M 37754	32mm	6pcs	48pcs	15.00kg	0.210kg
M 37755	64mm	3pcs	24pcs	15.20kg	0.640kg

- 铝合金刀体, GCr15 刀片, 快速打开, 提高工作效率。
- △ 本品属于易耗品, 不属于终身保用范围
- Aluminum body ,Gcr15 blade ,can open quickly to improve working efficiency
- △ No warranty as consumables

搭配使用零部件

金属管子割刀刀片
Metal Pipe Cutter Replaced Blades

侧视图



货号 Item No	规格 Size	单支重 NW/PC
M 99334	32mm	0.003kg
M 99335	64mm	0.007kg

- △ 本品属于易耗品, 不属于终身保用范围
- △ No warranty as consumables

PVC 自动管子割刀
Automatic PVC Pipe Cutter



货号 Item No	规格 Size	装盒数 Pc/Box	装箱数 Pc/Cartron	毛重 GW/CTN	单支重 NW/PC
a. M 37738	42mm(1-5/8")	6pcs	48pcs	23.04kg	0.470kg
b. M 37739	64mm (2.5")	6pcs	24pcs	0.700kg	0.700kg

- 铝合金刀体, 不锈钢三角刀片, 剪切省力, 自动打开。
- △ 本品属于易耗品, 不属于终身保用范围
- Aluminum body, stainless steel triangular blade, easy to cut, long using life
- △ No warranty as consumables

搭配使用零部件

PVC自动管子割刀刀片
Automatic PVC Pipe Cutter Replaced Blades



货号 Item No	规格 Size	单支重 NW/PC
M 99329	42mm(1-5/8")	0.070kg
M 99330	64mm(2.5")	0.10kg

- △ 本品属于易耗品, 不属于终身保用范围
- △ No warranty as consumables

PVC 管子割刀
PVC Pipe Cutter



货号 Item No	规格 Size	装盒数 Pc/Box	装箱数 Pc/Cartron	毛重 GW/CTN	单支重 NW/PC
M 37733	42mm(1-5/8")	6pcs	48pcs	16.60kg	0.313kg

- 铝合金刀体, 不锈钢刀片, 剪切省力, 使用寿命长
- △ 本品属于易耗品, 不属于终身保用范围
- Aluminum body, stainless steel blade, easy to cut, long using life
- △ No warranty as consumables

搭配使用零部件

PVC 管子割刀刀片
PVC Pipe Cutter Replaced Blades



货号 Item No	规格 Size	单支重 NW/PC
M 99324	42mm(1-5/8")	0.060kg

- △ 本品属于易耗品, 不属于终身保用范围
- △ No warranty as consumables

切割类工具

Cutting Tools

- 断线钳及替换钳头..... 96-97
- 剪类..... 97-99
- 钢锯及锯条..... 99
- 美工刀及替换刀片..... 99-100
- 锉刀..... 101-103
- 丝锥板牙组套..... 103
- Bolt cutter and replaced blades 96-97
- Snips 97-99
- Hacksaw and saw blade 99
- Utility knife and replace blades 99-100
- Files 101-103
- Screw Tap Set 103

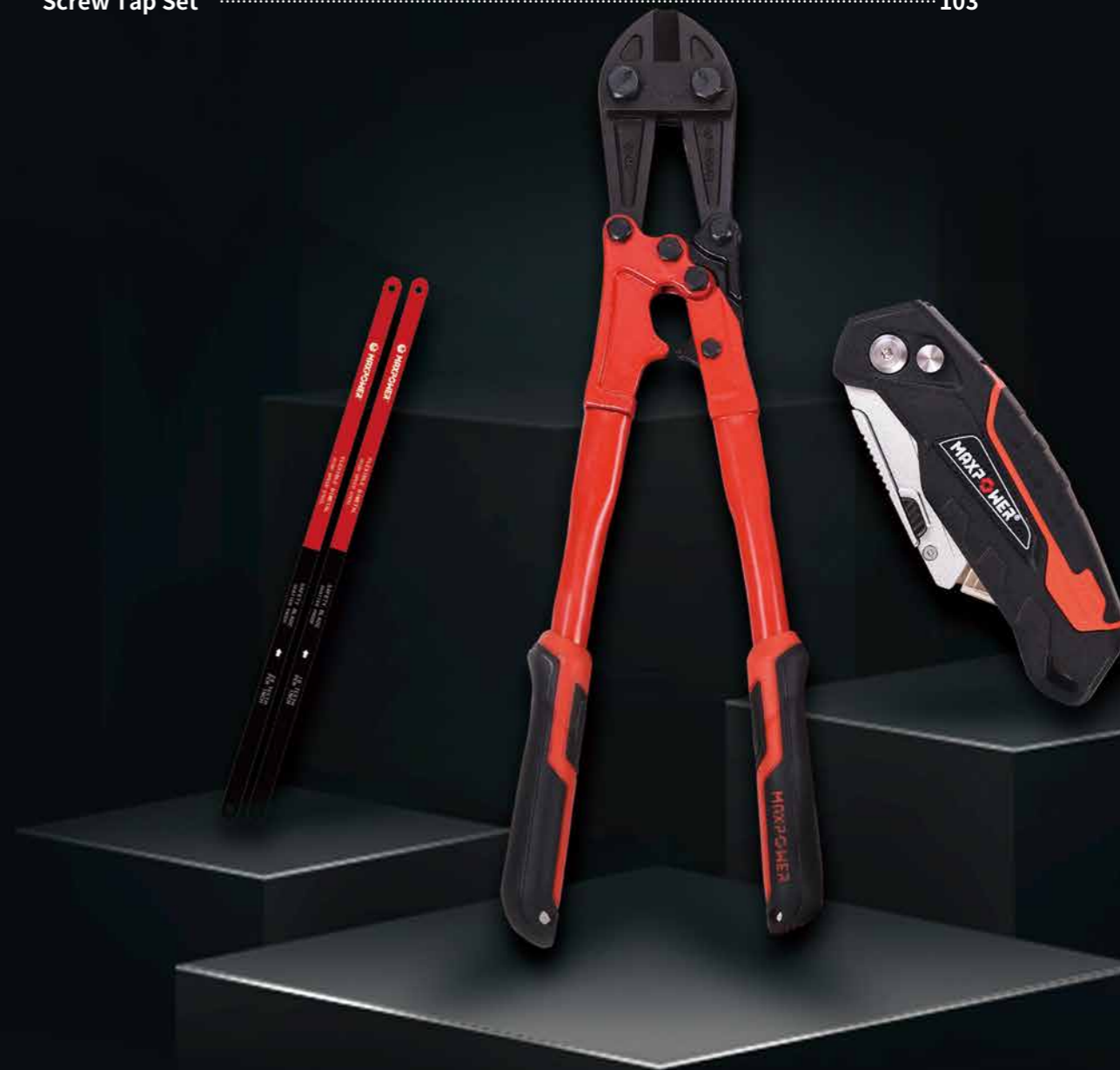

工业级断线钳 Bolt Cutter

CR-Mo 强剪切 工业级



此螺钉可微调刀口间隙

货号 Item No	规格 Size	L(总长) length	剪切直径 Cutting Dia.	装盒数 Pc/Box	装箱数 Pc/ Carton	毛重 GW/CTN	单支重 NW/PC
M33320	300mm(12")	328mm	4mm	1pc	24pcs	24.00kg	0.900kg
M33321	350mm(14")	366mm	5mm	1pc	24pcs	29.00kg	1.100kg
M33322	450mm(18")	464mm	6mm	1pc	12pcs	23.40kg	1.800kg
M33323	600mm(24")	626mm	8mm	1pc	8pcs	22.80kg	2.600kg
M33324	750mm(30")	758mm	10mm	1pc	6pcs	24.20kg	3.700kg
M33325	900mm(36")	907mm	12mm	1pc	4pcs	22.70kg	5.200kg
M33326	1050mm(42")	1050mm	14mm	1pc	2pcs	17.40kg	8.030kg

- 锻造连臂, 钳头为铬钼合金钢锻造而成
- 严格的刃口硬度控制, 防止崩刃及塌刃, 更长的使用寿命
- 使用更加方便, 操作更加省力
- 性能稳定, 经久耐用, 比普通断线钳寿命提高5倍以上
- 本品属于易耗品, 不属于终身保用范围
- Drop forged joint arms, drop forged CrMo jaws
- Strict control of blades hardness, longer life of using
- Higher blade cutting capacity
- Stable performance, life of using can be 5 times longer than common items
- No warranty as consumables

断线钳钳头 Replaced blades

CR-Mo 强剪切



货号 Item No	规格 Size	装盒数 Pc/Box	装箱数 Pc/ Carton	毛重 GW/CTN	单支重 NW/PC
M98105	450mm(18")	1pc	16pcs	9.20kg	0.520kg
M98106	600mm(24")	1pc	16pcs	14.80kg	0.860kg
M98107	750mm(30")	1pc	16pcs	21.80kg	1.300kg
M98108	900mm(36")	1pc	9pcs	19.00kg	1.910kg
M98109	1050mm(42")	1pc	9pcs	24.50kg	2.600kg
M98110	1200mm(48")	1pc	8pcs	24.00kg	2.660kg

- 铬钼合金钢锻造
- 本品属于易耗品, 不属于终身保用范围
- Drop forged CrMo
- No warranty as consumables

高档省力断线钳 Bolt Cutter

CR-Mo 强剪切 专利



货号 Item No	规格 Size	L(总长) length	剪切直径 Cutting Dia.	装盒数 Pc/Box	装箱数 Pc/ Carton	毛重 GW/CTN	单支重 NW/PC
M33410	300mm(12")	320mm	4mm	1pc	24pcs	19.80kg	0.900kg
M33411	350mm(14")	390mm	5mm	1pc	24pcs	27.50kg	1.100kg
M33412	450mm(18")	490mm	6mm	1pc	12pcs	21.00kg	1.800kg
M33413	600mm(24")	650mm	8mm	1pc	8pcs	22.50kg	2.600kg
M33414	750mm(30")	780mm	10mm	1pc	6pcs	25.50kg	3.700kg
M33415	900mm(36")	935mm	12mm	1pc	4pcs	25.80kg	5.200kg

- 专利设计, 比一般断线钳省力25%以上
- 刀头采用Cr-Mo, 更加持久耐用
- 双色手持胶柄, 符合人体工程学
- 本品属于易耗品, 不属于终身保用范围
- Patented design, saving more than 25% of labor than traditional bolt cutters.
- The cutter head is made of Cr-Mo for more durability.
- Ergonomic bi-color plastic handle.
- No warranty as consumables

免调断线钳 Bolt Cutter

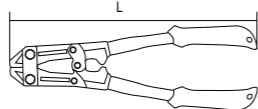

★售完升级

货号 Item No	规格 Size	L(总长) length	剪切直径 Cutting Dia.	装盒数 Pc/Box	装箱数 Pc/ Carton	毛重 GW/CTN	单支重 NW/PC
M33021	300mm(12")	328mm	4mm	1pc	24pcs	18.60kg	0.900kg
M33022	350mm(14")	366mm	5mm	1pc	24pcs	23.50kg	1.100kg
M33023	450mm(18")	464mm	6mm	1pc	12pcs	20.90kg	1.800kg
M33024	600mm(24")	626mm	8mm	1pc	8pcs	22.50kg	2.600kg
M33025	750mm(30")	758mm	10mm	1pc	6pcs	23.20kg	3.700kg
M33026	900mm(36")	907mm	12mm	1pc	4pcs	21.80kg	5.200kg
M33027	1050mm(42")	1050mm	14mm	1pc	2pcs	17.50kg	8.040kg

- 性能稳定, 经久耐用, 比普通断线钳寿命提高5倍以上
- 严格的刃口硬度控制, 防止崩刃及塌刃, 更长的使用寿命
- 使用更加方便, 操作更加省力
- 锻造连臂, 钳头为铬钼合金钢锻造而成
- 本品属于易耗品, 不属于终身保用范围
- Stable performance, life of using can be 5 times longer than common items
- Strict control of blades hardness, longer life of using
- Higher blade cutting capacity
- Drop forged joint arms, drop forged CrMo jaws
- No warranty as consumables

迷你断线钳 Mini Bolt Cutter

强剪切

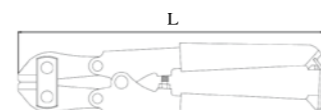

货号 Item No	规格 Size	L(总长) length	剪切直径 Cutting Dia.	装盒数 Pc/Box	装箱数 Pc/ Carton	毛重 GW/CTN	单支重 NW/PC
M33011	200mm(8")	214mm	3mm	6pcs	36pcs	11.80kg	0.280kg

- 合金钢刀头, 镍合金表面处理
- 本品属于易耗品, 不属于终身保用范围
- 合金钢刀头, 镍合金表面处理
- Alloy steel blades, nickel plated
- No warranty as consumables

迷你型断线钳 Mini Bolt Cutter

NEW



货号 Item No	规格 Size	L(总长) length	剪切直径 Cutting Dia.	装盒数 Pc/Box	装箱数 Pc/ Carton	毛重 GW/CTN	单支重 NW/PC
M33008	200mm(8")	216mm	3mm	6pcs	48pcs	0.37kg	19.50kg

- 产品经过锻造及热处理
- 舒适防滑手柄, 方便容易操作
- Made of drop forged steel, heat treated.
- Comfortable and anti-sliding rubber handle, easy operation

钢丝绳剪 Wire Rope Cutter

强剪切



货号 Item No	规格 Size	L(总长) length	剪切直径 Cutting Dia.	装盒数 Pc/Box	装箱数 Pc/ Carton	毛重 GW/CTN	单支重 NW/PC
M33654	450mm(18")	450mm	φ 12mm	1pc	12pcs	19.50kg	1.500kg
M33655	600mm(24")	600mm	φ 14mm	1pc	8pcs	21.50kg	2.400kg
M33657	900mm(36")	900mm	φ 16mm	1pc	4pcs	23.50kg	5.400kg
M33658	1050mm(42")	1050mm	φ 20mm	1pc	2pcs	17.00kg	7.500kg

- 铬硅锰合金钢材质, 黑色磷化
- 整体热处理, 刃口高频淬火, 刃口锋利
- 管柄喷塑处理美观不易生锈, 剪切后钢丝绳不散开, 省力省时
- 本品属于易耗品, 不属于终身保用范围
- Si2Mn alloy steel blades, black phosphated
- Body heat treatment, induction quenched the blade with high hardness
- No warranty as consumables

电缆剪 Cable Cutter

强剪切



货号 Item No	规格 Size	L(总长) length	剪切面积 Cutting Area	装盒数 Pc/Box	装箱数 Pc/ Carton	毛重 GW/CTN	单支重 NW/PC
M33864	350mm(14")	357mm	95mm ²	1pc	24pcs	16.00kg	0.600kg
M33865	450mm(18")	460mm	150mm ²	1pc	12pcs	14.00kg	1.000kg
M33866	600mm(24")	610mm	240mm ²	1pc	8pcs	16.00kg	1.800kg
M33868	900mm(36")	910mm	500mm ²	1pc	4pcs	18.50kg	4.200kg

- 整体热处理, 刃口高频淬火, 刃口锋利
- 管柄喷塑处理美观不易生锈, 不能剪钢丝绳
- 刀头铬钼钢锻造, 特殊热处理
- 请勿带电操作
- 本品属于易耗品, 不属于终身保用范围
- Whole treatment, induction quenched the blade with high hardness
- Drop forged Cr-Mo blades
- Do not use the product with power on.
- No warranty as consumables

左切省力航空剪 Labor Saving Aviation Snips-Cut Left

NEW



货号 Item No	规格 Size	L(总长) length	装盒数 Pc/Box	装箱数 Pc/ Carton	毛重 GW/CTN	单支重 NW/PC
M34920	250mm(10")	250mm	6pcs	36pcs	18.70kg	0.44kg

- 双杠杆省力设计
- 耐磨CR-MO钢刀头, 经受的住复合杠杆作用产生的巨大压力。
- 高杠杆, 复合设计, 可切割1.2mm(18号规格)的冷轧钢和0.7mm(22号规格)的不锈钢
- Double lever labor saving design.
- Wear resistant Cr-Mo steel blades are made to stand up to the tremendous pressures created by the compound lever action.
- High-leverage, compound cutting design for cuts of up to 1.2mm (18 gauge) cold-rolled steel and 0.7mm (22 gauge) stainless steel.

直切省力航空剪 Labor Saving Aviation Snips-Cut Straight

NEW

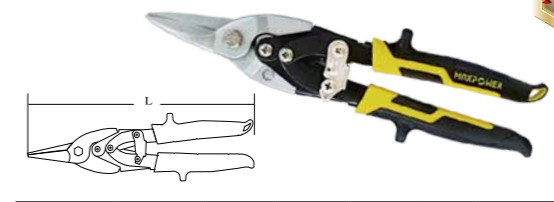

货号 Item No	规格 Size	L(总长) length	装盒数 Pc/Box	装箱数 Pc/ Carton	毛重 GW/CTN	单支重 NW/PC
M34922	250mm(10")	250mm	6pcs	36pcs	18.70kg	0.44kg

- 双杠杆省力设计
- 耐磨CR-MO钢刀头, 经受的住复合杠杆作用产生的巨大压力。
- 高杠杆, 复合设计, 可切割1.2mm(18号规格)的冷轧钢和0.7mm(22号规格)的不锈钢
- Double lever labor saving design.
- Wear resistant Cr-Mo steel blades are made to stand up to the tremendous pressures created by the compound lever action.
- High-leverage, compound cutting design for cuts of up to 1.2mm (18 gauge) cold-rolled steel and 0.7mm (22 gauge) stainless steel.

右切省力航空剪 Labor Saving Aviation Snips-Cut Right

NEW



货号 Item No	规格 Size	L(总长) length	装盒数 Pc/Box	装箱数 Pc/ Carton	毛重 GW/CTN	单支重 NW/PC
M34921	250mm(10")	250mm	6pcs	36pcs	18.70kg	0.44kg

- 双杠杆省力设计
- 耐磨CR-MO钢刀头, 经受的住复合杠杆作用产生的巨大压力。
- 高杠杆, 复合设计, 可切割1.2mm(18号规格)的冷轧钢和0.7mm(22号规格)的不锈钢
- Double lever labor saving design.
- Wear resistant Cr-Mo steel blades are made to stand up to the tremendous pressures created by the compound lever action.
- High-leverage, compound cutting design for cuts of up to 1.2mm (18 gauge) cold-rolled steel and 0.7mm (22 gauge) stainless steel.



双杠杆省力设计 —省时省力—



左切航空剪
Aviation Snips-Cut Left



货号 Item No	规格 Size	L(总长) length	装盒数 Pc/Box	装箱数 Pc/ Carton	毛重 GW/CTN	单支重 NW/PC
M 34911	250mm(10")	245mm	6pcs	36pcs	18.00kg	0.45kg

- 可剪切厚度 1.2mm 的冷轧钢板和厚度为 0.7mm 的不锈钢板。
- 刀片整体淬火处理
- 上下刀片间隙自动补偿, 切口光滑, 剪切轻快顺畅
- 锻造剪头
- △本品属于易耗品, 不属于终身保用范围
- Can cut cold-rolled steel with 1.2mm thickness and stainless steel plate with 0.7mm thickness
- Drop forged alloy steel blades, heat treatment
- △No warranty as consumables

直切航空剪
Aviation Snips-Cut Straight



货号 Item No	规格 Size	L(总长) length	装盒数 Pc/Box	装箱数 Pc/ Carton	毛重 GW/CTN	单支重 NW/PC
M 34913	250mm(10")	250mm	6pcs	36pcs	18.00kg	0.45kg

- 可剪切厚度 1.2mm 的冷轧钢板和厚度为 0.7mm 的不锈钢板。
- 刀片整体淬火处理
- 上下刀片间隙自动补偿, 切口光滑, 剪切轻快顺畅
- 锻造剪头
- △本品属于易耗品, 不属于终身保用范围
- Can cut cold-rolled steel with 1.2mm thickness and stainless steel plate with 0.7mm thickness
- Drop forged alloy steel blades, heat treatment
- △No warranty as consumables

右切航空剪
Aviation Snips-Cut Right

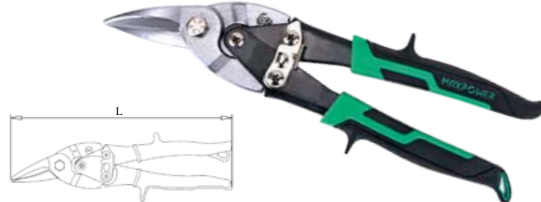

货号 Item No	规格 Size	L(总长) length	装盒数 Pc/Box	装箱数 Pc/ Carton	毛重 GW/CTN	单支重 NW/PC
M 34912	250mm(10")	245mm	6pcs	36pcs	18.00kg	0.45kg

- 可剪切厚度 1.2mm 的冷轧钢板和厚度为 0.7mm 的不锈钢板。
- 刀片整体淬火处理
- 上下刀片间隙自动补偿, 切口光滑, 剪切轻快顺畅
- 锻造剪头
- △本品属于易耗品, 不属于终身保用范围
- Can cut cold-rolled steel with 1.2mm thickness and stainless steel plate with 0.7mm thickness
- Drop forged alloy steel blades, heat treatment
- △No warranty as consumables

长直头多功能航空剪
Multifunction Aviation Snips



货号 Item No	规格 Size	L(总长) length	装盒数 Pc/Box	装箱数 Pc/ Carton	毛重 GW/CTN	单支重 NW/PC
M 34927	300mm(12")	274mm	6pcs	36pcs	17.00kg	0.390kg

- 优质合金钢锻造, 刀片整体淬火处理
- 剪铁丝网、胶皮
- △本品属于易耗品, 不属于终身保用范围
- Drop forged CrMo blades
- Cutting barbed wire and rubber
- △No warranty as consumables

短直头多功能航空剪
Aviation Snips-Cut Straight



货号 Item No	规格 Size	L(总长) length	装盒数 Pc/Box	装箱数 Pc/ Carton	毛重 GW/CTN	单支重 NW/PC
M 34926	250mm(10")	228mm	6pcs	36pcs	14.40kg	0.390kg

- 优质合金钢锻造, 刀片整体淬火处理
- 剪铁丝网、胶皮
- △本品属于易耗品, 不属于终身保用范围
- Drop forged CrMo blades
- Cutting barbed wire and rubber
- △No warranty as consumables

钢筋剪断机
Rebar Cutter And Bender

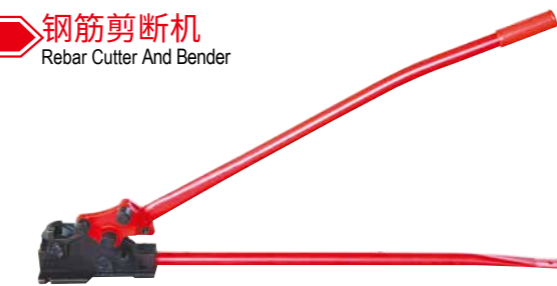

货号 Item No	总长 length	剪切直径 Cutting Dia.	装箱数 Pc/ Carton	净重 NW/CTN
M 33450	1300mm	≤16mm	1pc	18.40kg

- 铬钼钢刀片, 适用于建筑工地, 可以弯曲、剪断钢筋。
- Drop forged CrMo blades ,Suitable to be used ,On construction site,With the function of bent steel



铁皮剪
Tinner Snips



货号 Item No	规格 Size	L(总长) length	装盒数 Pc/Box	装箱数 Pc/ Carton	毛重 GW/CTN	单支重 NW/PC
M 34872	175mm(7")	177mm	6pcs	36pcs	12.00kg	0.360kg
M 34873	250mm(10")	258mm	6pcs	36pcs	21.00kg	0.540kg
M 34874	300mm(12")	307mm	4pcs	24pcs	18.50kg	0.730kg
M 34875	350mm(14")	355mm	4pcs	24pcs	25.50kg	1.000kg

- 使用寿命长, 剪切厚铁板更省力
- △本品属于易耗品, 不属于终身保用范围
- Long life of using, easy to cut thick steel plate
- △No warranty as consumables

双色塑柄不锈钢布剪刀
Stainless Steel Scissors



货号 Item No	规格 Size	L	装盒数 Pc/Box	装箱数 Pc/ Carton	毛重 GW/CTN	单支重 NW/PC
M 34642	200mm(8")	210mm	6pcs	72pcs	8.06kg	0.081kg

- 刀片材料3CR13, 热处理HRC50以上
- ABS+TPR双色塑柄, 握持舒适
- Blade material 3CR13, heat treated, hardness≥HRC50
- ABS+TPR bi-color comfortable grip

铝合金钢锯架
Hacksaw

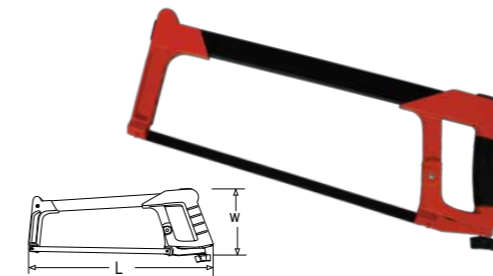

货号 Item No	规格 Size	L(总长) length	W	装盒数 Pc/Box	装箱数 Pc/ Carton	毛重 GW/CTN	单支重 NW/PC
M 34768	300mm(12")	400mm	143mm	6pcs	36pcs	20.5kg	0.500kg

- 铝合金钢管构造, 夹紧力达 32000 磅 / 平方英尺
- 省力手柄设计, 锯条固定牢固, 不变形, 不断锯条, 安全可靠
- 强劲锁定装置, 使用更安全, 附锯条一支
- △本品属于易耗品, 不属于终身保用范围
- Aluminum alloy and steel tube
- Strong latched set, safety and facility with one cutting blade
- Handle with labor saving design
- △No warranty as consumables

双金属柔性锯条
Saw Blade



货号 Item No	规格 Size	装盒数 Pc/Box	装箱数 Pc/ Carton	毛重 GW/CTN	单支重 NW/PC
M 34774	300mm(12") × 18T	100pcs	1000pcs	20.2kg	0.019kg
M 34775	300mm(12") × 24T	100pcs	1000pcs	19.8kg	0.018kg

- 齿口为高速钢, 齿身为优质弹簧钢, 经电子束焊接而成。
- 弹性优越, 锯齿锋利, 切割流畅, 韧性佳。
- △本品属于易耗品, 不属于终身保用范围
- Saw tool is high-speed steel and body is spring steel, was jointed through electron beam.
- It has superior flexible, sharp saw-tooth and fluency cutting
- △No warranty as consumables

双色柄美工刀
Utility knife



货号 Item No	规格 Size	装盒数 Pc/Box	装箱数 Pc/ Carton	毛重 GW/CTN	单支重 NW/PC
M 34530	80 × 9mm	24pcs	288pcs	15.40kg	0.049kg
M 34531	100 × 18mm	24pcs	192pcs	18.50kg	0.094kg

- 双色包胶手柄, 美观舒适
- △本品属于易耗品, 不属于终身保用范围
- Comfortable double color handle
- △No warranty as consumables

双色柄三连发美工刀
Utility Knife With 3 Blades



货号 Item No	规格 Size	装盒数 Pc/Box	装箱数 Pc/ Carton	毛重 GW/CTN	单支重 NW/PC
M 34534	80 × 9mm	12pcs	144pcs	11.00kg	0.069kg
M 34532	100 × 18mm	12pcs	144pcs	21.80kg	0.139kg

- 内藏 3 片刀片 · 舒适的手柄设计 · 有锁定按钮, 锁力更强
- △本品属于易耗品, 不属于终身保用范围
- There are 3 blades hidden inside · Comfortable handle · Locked automatically
- △No warranty as consumables

双色柄大号美工刀
Utility knife



货号 Item No	规格 Size	装盒数 Pc/Box	装箱数 Pc/Carton	毛重 GW/CTN	单支重 NW/PC
M 34529	125x25mm	24pcs	144pcs	18.20kg	0.12kg

△ 本品属于易耗品, 不属于终身保用范围
△ No warranty as consumables

铝合金折叠实用刀
Foldable Aluminum Alloy Utility Knife



内含三支刀片
(产品共带四支刀片)

货号 Item No	规格 Size	装盒数 Pc/Box	装箱数 Pc/Carton	毛重 GW/CTN	单支重 NW/PC
M34526	60x19mm	12pcs	96pcs	14.00kg	0.135kg

△ 本品属于易耗品, 不属于终身保用范围
△ Made of superior alloy steel
△ No warranty as consumables

10PCS 梯形刀片
10PCS Utility Knife Blade



货号 Item No	规格 Size	装盒数 Pc/Box	装箱数 Pc/Carton	毛重 GW/CTN	单支重 NW/PC
M 34544	60 × 19mm	10sets	200sets	9.50kg	0.043kg

· 采用优质合金钢而成
△ 本品属于易耗品, 不属于终身保用范围
△ Made of superior alloy steel
△ No warranty as consumables

10PCS 重型大号美工刀片
10PCS Replacement Blade

SK2



货号 Item No	规格 Size	装盒数 Pc/Box	装箱数 Pc/Carton	毛重 GW/CTN	单支重 NW/PC
M 34541	125mm x 25mm (6节)	10sets	120sets	2.00kg	0.019kg

· 刀片锋利, 采用SK2材质
△ 本品属于易耗品, 不属于终身保用范围
· Blades are sharp, Using SK2 material
△ No warranty as consumables

10PCS 美工刀刀片
10PCS Replacement Blade

SK2

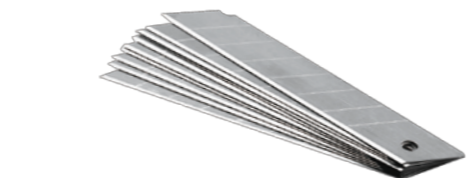

货号 Item No	规格 Size	装盒数 Pc/Box	装箱数 Pc/Carton	毛重 GW/CTN	单支重 NW/PC
M 34542	100 × 18mm (8节)	10 sets	240sets	18.40kg	0.007kg

· 刀片锋利, 采用SK2材质
△ 本品属于易耗品, 不属于终身保用范围
· Blades are sharp, Using SK2 material
△ No warranty as consumables

10PCS 美工刀刀片
10PCS Replacement Blade



货号 Item No	规格 Size	装盒数 Pc/Box	装箱数 Pc/Carton	毛重 GW/CTN	单支重 NW/PC
M 34540	80 × 9mm	30sets	240sets	8.60kg	0.003kg
M 34538	100 × 18mm (8节)	10sets	240sets	18.40kg	0.007kg
M 34539	100 × 18mm (14节)	10sets	240sets	18.40kg	0.007kg

· 刀片锋利, 小心拿放
△ 本品属于易耗品, 不属于终身保用范围
· Blades are sharp, be careful for replacement
△ No warranty as consumables

金刚石整形锉刀
Diamond Plastic File



- | | |
|---------------------------|---------------------------------------|
| 平头扁锉
Flat File | 尖头双边圆扁锉
Bilateral Round Flat File |
| 尖头半圆锉
Hair Circle File | 尖头刀型锉
Knife Type File |
| 尖头方锉
Square File | 尖头单面三角锉
Single Sided Triangle File |
| 尖头等边三角锉
Triangle File | 尖头扁圆锉
Oblate File |
| 尖头圆锉
Circle File | 尖头椭圆锉
Oval File |

★售完下架

货号 Item No	型号 Type	规格 Size	装盒数 Pc/Box	装箱数 Pc/Carton	毛重 GW/CTN	单支重 NW/PC
M61210	金刚石平头扁锉	3 × 140mm	50pcs	600pcs	10.50kg	0.015kg
M61211	金刚石平头扁锉	4 × 160mm	50pcs	600pcs	16.00kg	0.025kg
M61212	金刚石平头扁锉	5 × 180mm	50pcs	600pcs	22.00kg	0.035kg
M61216	金刚石尖头半圆锉	3 × 140mm	50pcs	600pcs	10.00kg	0.015kg
M61217	金刚石尖头半圆锉	4 × 160mm	50pcs	600pcs	15.00kg	0.023kg
M61218	金刚石尖头半圆锉	5 × 180mm	50pcs	600pcs	21.00kg	0.033kg
M61222	金刚石尖头圆锉	3 × 140mm	50pcs	600pcs	10.00kg	0.015kg
M61223	金刚石尖头圆锉	4 × 160mm	50pcs	600pcs	15.00kg	0.023kg
M61224	金刚石尖头圆锉	5 × 180mm	50pcs	600pcs	21.00kg	0.033kg
M07800	10pcs 金刚石异形什锦锉	10pcs (3 × 140mm)	10sets	100sets	11.80kg	0.110kg
M07804	10pcs 金刚石异形什锦锉	10pcs (3 × 140mm)	10sets	100sets	11.50kg	0.110kg
M07795	10pcs 金刚石整形锉	10pcs (3 × 140mm)	10sets	100sets	12.50kg	0.110kg
M07786	3pcs 金刚石整形锉刀	3pcs (3 × 140mm)	20sets	200sets	7.50kg	0.035kg
M07796	10pcs 金刚石整形锉	10pcs (4 × 160mm)	10sets	100sets	19.20kg	0.180kg
M07787	3pcs 金刚石整形锉刀	3pcs (4 × 160mm)	20sets	200sets	12.20kg	0.055kg
M07797	10pcs 金刚石整形锉	10pcs (5 × 180mm)	10sets	100sets	29.00kg	0.280kg
M07793	5pcs 金刚石整形锉刀	5pcs (5 × 180mm)	10sets	100sets	17.00kg	0.160kg
M07788	3pcs 金刚石整形锉刀	3pcs (5 × 180mm)	20sets	200sets	20.30kg	0.095kg

· 锉体采用优质 45# 钢锻造, 表面由高强度的人造钻石电镀而成, 耐磨损、效率高。
· 本产品适用于锉削硬度高的金属, 如硬质合金, 经过淬火或渗氮的工具、合金钢刀具、模具和工夹具等, 也可用于硬度较高而脆的非金属材料的加工, 如玻璃、陶瓷、珠宝玉器。
· Drop forged with 45# carbon steel, plated with synthetic
· Diamond on the surface, durable and high efficiency

胶柄平锉
Flat File



粗齿胶柄平锉
Coarse Teeth Flat File

货号 Item No	规格 Size	装盒数 Pc/Box	装箱数 Pc/Carton	毛重 GW/CTN	单支重 NW/PC
M 61102	150mm(6")	10pcs	100pcs	15.00kg	0.140kg
M 61103	200mm(8")	10pcs	100pcs	21.50kg	0.200kg
M 61104	250mm(10")	10pcs	60pcs	20.00kg	0.317kg
M 61105	300mm(12")	10pcs	60pcs	29.50kg	0.300kg

中齿胶柄平锉
Middle Teeth Flat File

货号 Item No	规格 Size	装盒数 Pc/Box	装箱数 Pc/Carton	毛重 GW/CTN	单支重 NW/PC
M 61108	150mm(6")	10pcs	100pcs	15.00kg	0.140kg
M 61109	200mm(8")	10pcs	100pcs	21.50kg	0.200kg
M 61110	250mm(10")	10pcs	60pcs	20.00kg	0.317kg
M 61111	300mm(12")	10pcs	60pcs	29.50kg	0.300kg

细齿胶柄平锉
Fine Teeth Flat File

货号 Item No	规格 Size	装盒数 Pc/Box	装箱数 Pc/Carton	毛重 GW/CTN	单支重 NW/PC
M 61114	150mm(6")	10pcs	100pcs	15.00kg	0.140kg
M 61115	200mm(8")	10pcs	100pcs	22.00kg	0.200kg
M 61116	250mm(10")	10pcs	60pcs	22.00kg	0.317kg
M 61117	300mm(12")	10pcs	60pcs	25.00kg	0.300kg

· 采用优质T12钢锻造而成, 锋利耐用, 含有钨等耐磨耐高温元素
· 锉齿表面热处理, 涂层经久耐磨
· 锉齿形状均匀同一, 锉削稳定快速
· 橡胶手柄, 舒适防滑

△ 本品属易耗品, 不属于终身保用范围

· Drop forged with T12, sharp and durable
· Ideal tooth depth and tooth pitch is sure to clean neat
· Comfortable grip

△ No warranty as consumables

胶柄方锉
Square File



粗齿胶柄方锉
Coarse Teeth Square File

货号 Item No	规格 Size	装盒数 Pc/Box	装箱数 Pc/Carton	毛重 GW/CTN	单支重 NW/PC
M 61122	150mm(6")	10pcs	100pcs	12.00kg	0.100kg
M 61123	200mm(8")	10pcs	100pcs	16.00kg	0.150kg
M 61124	250mm(10")	10pcs	60pcs	14.00kg	0.200kg
M 61125	300mm(12")	10pcs	60pcs	21.00kg	0.317kg

中齿胶柄方锉
Middle Teeth Square File

货号 Item No	规格 Size	装盒数 Pc/Box	装箱数 Pc/Carton	毛重 GW/CTN	单支重 NW/PC
M 61128	150mm(6")	10pcs	100pcs	12.00kg	0.100kg
M 61129	200mm(8")	10pcs	100pcs	16.00kg	0.150kg
M 61130	250mm(10")	10pcs	60pcs	14.00kg	0.200kg
M 61131	300mm(12")	10pcs	60pcs	21.00kg	0.317kg

细齿胶柄方锉
Fine Teeth Square File

货号 Item No	规格 Size	装盒数 Pc/Box	装箱数 Pc/Carton	毛重 GW/CTN	单支重 NW/PC
M 61134	150mm(6")	10pcs	100pcs	12.00kg	0.100kg
M 61135	200mm(8")	10pcs	100pcs	16.00kg	1.150kg
M 61136	250mm(10")	10pcs	60pcs	14.00kg	0.200kg
M 61137	300mm(12")	10pcs	60pcs	21.00kg	0.317kg

- 采用优质T12钢锻造而成, 锋利耐用, 含有钨等耐磨耐高温元素
- 锉齿表面热处理, 涂层经久耐磨
- 锉齿形状均匀同一, 锉削稳定快速
- 橡胶手柄, 舒适防滑
- △ 本品属易耗品, 不属于终身保用范围
- Drop forged with T12, sharp and durable
- Ideal tooth depth and tooth pitch is sure to clean neat
- Comfortable grip
- △ No warranty as consumables

胶柄半圆锉
Semi Circle File



粗齿胶柄半圆锉
Coarse Teeth Half Round

货号 Item No	规格 Size	装盒数 Pc/Box	装箱数 Pc/Carton	毛重 GW/CTN	单支重 NW/PC
M 61142	150mm(6")	10pcs	100pcs	15.20kg	0.145kg
M 61143	200mm(8")	10pcs	100pcs	20.70kg	0.200kg
M 61144	250mm(10")	10pcs	60pcs	20.68kg	0.333kg
M 61145	300mm(12")	10pcs	60pcs	28.70kg	0.467kg

中齿胶柄半圆锉
Middle Teeth Half Round

货号 Item No	规格 Size	装盒数 Pc/Box	装箱数 Pc/Carton	毛重 GW/CTN	单支重 NW/PC
M 61148	150mm(6")	10pcs	100pcs	15.20kg	0.145kg
M 61149	200mm(8")	10pcs	100pcs	20.70kg	0.200kg
M 61150	250mm(10")	10pcs	60pcs	20.68kg	0.333kg
M 61151	300mm(12")	10pcs	60pcs	28.70kg	0.467kg

细齿胶柄半圆锉
Fine Teeth Half Round

货号 Item No	规格 Size	装盒数 Pc/Box	装箱数 Pc/Carton	毛重 GW/CTN	单支重 NW/PC
M 61154	150mm(6")	10pcs	100pcs	15.20kg	0.145kg
M 61155	200mm(8")	10pcs	100pcs	20.70kg	0.200kg
M 61156	250mm(10")	10pcs	60pcs	20.68kg	0.333kg
M 61157	300mm(12")	10pcs	60pcs	28.70kg	0.467kg

- 采用优质T12钢锻造而成, 锋利耐用, 含有钨等耐磨耐高温元素
- 锉齿表面热处理, 涂层经久耐磨
- 锉齿形状均匀同一, 锉削稳定快速
- 橡胶手柄, 舒适防滑
- △ 本品属易耗品, 不属于终身保用范围
- Drop forged with T12, sharp and durable
- Ideal tooth depth and tooth pitch is sure to clean neat
- Comfortable grip
- △ No warranty as consumables

中齿胶柄圆锉
Middle Teeth Round



货号 Item No	规格 Size	装盒数 Pc/Box	装箱数 Pc/Carton	毛重 GW/CTN	单支重 NW/PC
M 61168	150mm(6")	10pcs	100pcs	15.00kg	0.100kg
M 61169	200mm(8")	10pcs	100pcs	19.00kg	0.140kg
M 61170	250mm(10")	10pcs	60pcs	20.00kg	0.175kg
M 61171	300mm(12")	10pcs	60pcs	24.00kg	0.283kg

- 采用优质T12钢锻造而成, 锋利耐用, 含有钨等耐磨耐高温元素
- 锉齿表面热处理, 涂层经久耐磨
- 锉齿形状均匀同一, 锉削稳定快速
- 橡胶手柄, 舒适防滑
- △ 本品属易耗品, 不属于终身保用范围
- Drop forged with T12, sharp and durable
- Ideal tooth depth and tooth pitch is sure to clean neat
- Comfortable grip
- △ No warranty as consumables

中齿胶柄三角锉
Middle Teeth Triangular



货号 Item No	规格 Size	装盒数 Pc/Box	装箱数 Pc/Carton	毛重 GW/CTN	单支重 NW/PC
M 61188	150mm(6")	10pcs	100pcs	15.00kg	0.130kg
M 61189	200mm(8")	10pcs	100pcs	19.00kg	0.190kg
M 61190	250mm(10")	10pcs	60pcs	20.00kg	0.275kg
M 61191	300mm(12")	10pcs	60pcs	24.00kg	0.400kg

- 采用优质T12钢锻造而成, 锋利耐用, 含有钨等耐磨耐高温元素
- 锉齿表面热处理, 涂层经久耐磨
- 锉齿形状均匀同一, 锉削稳定快速
- 橡胶手柄, 舒适防滑
- △ 本品属易耗品, 不属于终身保用范围
- Drop forged with T12, sharp and durable
- Ideal tooth depth and tooth pitch is sure to clean neat
- Comfortable grip
- △ No warranty as consumables

丝锥板牙组套
Screw Tap Set



★此产品售完下架

货号 Item No	规格 Size	装盒数 Pc/Box	装箱数 Pc/Carton	每套重量 Weight Per Set	毛重 GW/CTN
M 07652	40pcs	6pcs	10pcs	1.20kg	13.00kg

- 采用优质Gcr15钢锻造而成, 锋利耐用, 含有钨等耐磨耐高温元素
- 锉齿表面热处理, 涂层经久耐磨
- 锉齿形状均匀同一, 锉削稳定快速
- 橡胶手柄, 舒适防滑
- △ 本品属易耗品, 不属于终身保用范围
- Drop forged with Gcr15, sharp and durable
- Ideal tooth depth and tooth pitch is sure to clean neat
- Comfortable grip
- △ No warranty as consumables

什锦锉
Needle Files



- 平头扁锉 • 尖头半圆锉 • 尖头方锉
- 尖头等边三角锉 • 尖头圆锉 • 尖头双边圆扁锉
- 尖头刀型锉 • 尖头单面三角锉 • 尖头扁圆锉 • 尖头椭圆锉

货号 Item No	规格 Size	装箱数 Pc/Box	毛重 GW/CTN	单支重 NW/PC
M 07783	10pcs(4x160mm)	100pcs	17.00kg	0.16kg

- △ 本品属于易耗品, 不属于终身保用范围
- △ No warranty as consumables

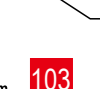
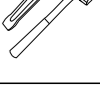
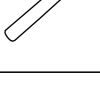
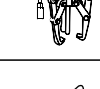
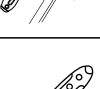
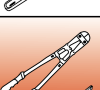

旋具类、测量类、敲击类工具

Screwdriver Series / Measurement Tools / Striking Tools

旋具类	
螺丝批	105-108
测量类工具	
卷尺	109-111
直尺及水平尺	110-111
敲击类工具	
锤子	112-113
扁凿	114
样冲组套	115-116
Screwdriver Series	
Screwdriver	105-108
Measurement Tools	
Tape	109-111
Ruler and level	110-111
Striking Tools	
Hammer	112-113
Chisel	114
Punching Set	115-116



十字螺丝批 Screwdriver Phillips



货号 Item No	规格 Size	装盒数 Pc/Box	装箱数 Pc/Carton	毛重 GW/CTN	单支重 NW/PC
M55276	PH0x75	12pcs	144pcs	3.60kg	0.02kg
M55277	PH0x100	12pcs	144pcs	3.80kg	0.02kg
M55278	PH0x150	12pcs	144pcs	4.40kg	0.02kg
M55279	PH0x200	12pcs	144pcs	4.90kg	0.03kg
M55280	PH1x75	12pcs	120pcs	7.80kg	0.05kg
M55281	PH1x100	12pcs	120pcs	8.50kg	0.06kg
M55282	PH1x125	12pcs	120pcs	8.80kg	0.06kg
M55283	PH1x150	12pcs	120pcs	9.20kg	0.07kg
M55284	PH1x200	12pcs	120pcs	10.17kg	0.07kg
M55285	PH1x250	12pcs	120pcs	11.50kg	0.08kg
M55286	PH1x300	12pcs	120pcs	12.40kg	0.09kg
M55288	PH2x100	12pcs	120pcs	12.30kg	0.09kg
M55289	PH2x125	12pcs	120pcs	13.00kg	0.09kg
M55290	PH2x150	12pcs	120pcs	13.60kg	0.10kg
M55291	PH2x200	12pcs	120pcs	15.20kg	0.11kg
M55292	PH2x250	12pcs	120pcs	17.30kg	0.14kg
M55293	PH2x300	12pcs	120pcs	18.60kg	0.16kg
M55294	PH3x200	12pcs	72pcs	13.00kg	0.19kg
M55295	PH3x250	12pcs	72pcs	15.00kg	0.21kg
M55296	PH3x300	12pcs	72pcs	16.50kg	0.23kg

- 刀杆采用优质6150铬钒合金钢制作，特殊热处理
- 整体淬火，刀头发黑处理，既保证强度又能提高使用寿命
- 广泛应用于各类螺丝型紧固件
- 刀杆头部带强磁性
- 手柄采用PP+TPR组合注塑，外形美观，使用舒适
- The blade is made of high-quality 6150 chromium-vanadium steel with special heat treatment.
- Full body quenched, blackend head. High strength and increased service life.
- Widely used in all kinds of screw fasteners.
- The head of the blade has strong magnetism.
- PP+TPR injection molded handle, beautiful and comfortable.

一字螺丝批 Screwdriver Slotted

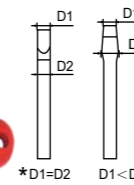

·带*规格：刀头宽度、刀头肩宽与刀杆直径一致，更适合深入机电箱柜或近似的狭窄孔径内作业

货号 Item No	规格 Size	装盒数 Pc/Box	装箱数 Pc/Carton	毛重 GW/CTN	单支重 NW/PC
* M55226	3x75mm	12pcs	144pcs	3.60kg	0.02kg
* M55227	3x100mm	12pcs	144pcs	3.80kg	0.02kg
* M55228	3x150mm	12pcs	144pcs	4.40kg	0.02kg
* M55229	3x200mm	12pcs	144pcs	4.90kg	0.03kg
* M55230	5x75mm	12pcs	120pcs	8.40kg	0.05kg
* M55231	5x100mm	12pcs	120pcs	8.40kg	0.05kg
* M55232	5x125mm	12pcs	120pcs	8.80kg	0.06kg
* M55233	5x150mm	12pcs	120pcs	9.20kg	0.07kg
* M55234	5x200mm	12pcs	120pcs	10.70kg	0.07kg
* M55235	5x250mm	12pcs	120pcs	11.50kg	0.08kg
* M55236	5x300mm	12pcs	120pcs	12.70kg	0.09kg
M55238	6x100mm	12pcs	120pcs	12.40kg	0.09kg
M55239	6x125mm	12pcs	120pcs	13.00kg	0.09kg
M55240	6x150mm	12pcs	120pcs	13.70kg	0.10kg
M55241	6x200mm	12pcs	120pcs	15.10kg	0.11kg
M55242	6x250mm	12pcs	120pcs	16.80kg	0.14kg
M55243	6x300mm	12pcs	120pcs	18.60kg	0.16kg
M55244	8x200mm	12pcs	72pcs	13.00kg	0.19kg
M55245	8x250mm	12pcs	72pcs	15.00kg	0.21kg
M55246	8x300mm	12pcs	72pcs	16.10kg	0.23kg

- 刀杆采用优质6150铬钒合金钢制作，特殊热处理
- 整体淬火，刀头发黑处理，既保证强度又能提高使用寿命
- 广泛应用于各类螺丝型紧固件
- 刀杆头部带强磁性
- 手柄采用PP+TPR组合注塑，外形美观，使用舒适
- The blade is made of high-quality 6150 chromium-vanadium steel with special heat treatment.
- Full body quenched, blackend head. High strength and increased service life.
- Widely used in all kinds of screw fasteners.
- The head of the blade has strong magnetism.
- PP+TPR injection molded handle, beautiful and comfortable.

穿芯柄十字螺丝批 Screwdriver Phillips



货号 Item No	规格 Size	装盒数 Pc/Box	装箱数 Pc/Carton	毛重 GW/CTN	单支重 NW/PC
M57362	PH2x100mm	12pcs	120pcs	18.10kg	0.13kg
M57363	PH2x150mm	12pcs	120pcs	19.60kg	0.15kg
M57364	PH2x200mm	12pcs	120pcs	21.20kg	0.16kg
M57365	PH3x150mm	12pcs	72pcs	16.00kg	0.20kg
M57366	PH3x200mm	12pcs	72pcs	17.50kg	0.22kg
M57367	PH3x250mm	12pcs	72pcs	19.20kg	0.24kg
M57368	PH3x300mm	12pcs	72pcs	20.70kg	0.27kg

- 刀杆采用优质6150铬钒合金钢制作，特殊热处理
- 整体淬火，刀头发黑处理，既保证强度又能提高使用寿命
- 贯通式批杆，适合敲击使用，六角批杆持有加力设计
- The blade is made of high-quality 6150 chromium-vanadium steel with special heat treatment.
- Full body quenched, blackend head. High strength and increased service life.
- Through-type hexagonal rod, suitable for striking and force-adding use.

穿芯柄一字螺丝批 Screwdriver Slotted



货号 Item No	规格 Size	装盒数 Pc/Box	装箱数 Pc/Carton	毛重 GW/CTN	单支重 NW/PC
M57312	6x100mm	12pcs	120pcs	18.10kg	0.13kg
M57313	6x150mm	12pcs	120pcs	19.60kg	0.15kg
M57314	6x200mm	12pcs	120pcs	21.20kg	0.16kg
M57315	8x150mm	12pcs	72pcs	15.80kg	0.20kg
M57316	8x200mm	12pcs	72pcs	17.30kg	0.22kg
M57317	8x250mm	12pcs	72pcs	19.20kg	0.24kg
M57318	8x300mm	12pcs	72pcs	20.70kg	0.27kg

- 刀杆采用优质6150铬钒合金钢制作，特殊热处理
- 整体淬火，刀头发黑处理，既保证强度又能提高使用寿命
- 贯通式批杆，适合敲击使用，六角批杆持有加力设计
- The blade is made of high-quality 6150 chromium-vanadium steel with special heat treatment.
- Full body quenched, blackend head. High strength and increased service life.
- Through-type hexagonal rod, suitable for striking and force-adding use.



耐油柄十字螺丝批

Screwdriver Phillips



货号 Item No	规格 Size	装盒数 Pc/Box	装箱数 Pc/ Carton	毛重 GW/CTN	单支重 NW/PC
M 55251	PH0 × 75	12pcs	144pcs	5.60kg	0.030kg
M 55252	PH0 × 100	12pcs	144pcs	5.80kg	0.031kg
M 55253	PH0 × 150	12pcs	144pcs	6.70kg	0.034kg
M 55254	PH0 × 200	12pcs	144pcs	7.40kg	0.045kg
M 55255	PH1 × 75	12pcs	120pcs	8.00kg	0.055kg
M 55256	PH1 × 100	12pcs	120pcs	9.20kg	0.060kg
M 55258	PH1 × 150	12pcs	120pcs	10.10kg	0.075kg
M 55259	PH1 × 200	12pcs	120pcs	11.00kg	0.075kg
M 55260	PH1 × 250	12pcs	120pcs	12.00kg	0.088kg
M 55261	PH1 × 300	12pcs	120pcs	13.50kg	0.096kg
M 55262	PH2 × 38	12pcs	120pcs	6.20kg	0.040kg
M 55263	PH2 × 100	12pcs	120pcs	11.80kg	0.085kg
M 55264	PH2 × 125	12pcs	120pcs	13.00kg	0.090kg
M 55265	PH2 × 150	12pcs	120pcs	13.50kg	0.095kg
M 55266	PH2 × 200	12pcs	120pcs	15.30kg	0.117kg
M 55267	PH2 × 250	12pcs	120pcs	17.60kg	0.125kg
M 55268	PH2 × 300	12pcs	120pcs	18.20kg	0.138kg
M 55272	PH3 × 150	6pcs	72pcs	13.96kg	0.180kg
M 55269	PH3 × 200	6pcs	72pcs	13.26kg	0.158kg
M 55270	PH3 × 250	6pcs	72pcs	15.40kg	0.194kg
M 55271	PH3 × 300	6pcs	72pcs	17.00kg	0.215kg

- 刀杆采用优质S2 加工而成，整体热处理
- 头部带强磁双色注塑手柄，手感舒适
- 柄部有尾孔方便加力柄头部有十字标志方便取用
- Made of S2, heat treatment
- With magnet on the head, comfortable

耐油柄一字螺丝批

Screwdriver Slotted



货号 Item No	规格 Size	装盒数 Pc/Box	装箱数 Pc/ Carton	毛重 GW/CTN	单支重 NW/PC
M 55201	3 × 75	12pcs	144pcs	5.60kg	0.030kg
M 55202	3 × 100	12pcs	144pcs	6.10kg	0.031kg
M 55203	3 × 150	12pcs	144pcs	6.70kg	0.034kg
M 55204	3 × 200	12pcs	144pcs	7.40kg	0.045kg
M 55205	5 × 75	12pcs	120pcs	8.00kg	0.055kg
M 55206	5 × 100	12pcs	120pcs	9.00kg	0.060kg
M 55208	5 × 150	12pcs	120pcs	10.40kg	0.075kg
M 55209	5 × 200	12pcs	120pcs	11.00kg	0.075kg
M 55210	5 × 250	12pcs	120pcs	12.00kg	0.088kg
M 55211	5 × 300	12pcs	120pcs	13.00kg	0.096kg
M 55212	6 × 38	12pcs	120pcs	6.20kg	0.040kg
M 55213	6 × 100	12pcs	120pcs	11.80kg	0.085kg
M 55214	6 × 125	12pcs	120pcs	13.00kg	0.090kg
M 55215	6 × 150	12pcs	120pcs	13.50kg	0.095kg
M 55216	6 × 200	12pcs	120pcs	14.50kg	0.117kg
M 55217	6 × 250	12pcs	120pcs	16.50kg	0.125kg
M 55218	6 × 300	12pcs	120pcs	17.66kg	0.138kg
M 55222	8 × 150	6pcs	72pcs	13.96kg	0.180kg
M 55219	8 × 200	6pcs	72pcs	13.24kg	0.158kg
M 55220	8 × 250	6pcs	72pcs	15.60kg	0.194kg
M 55221	8 × 300	6pcs	72pcs	17.00kg	0.215kg

- 刀杆采用优质S2 加工而成，整体热处理
- 头部带强磁双色注塑手柄，手感舒适
- 柄部有尾孔方便加力柄头部有十字标志方便取用
- Made of S2, heat treatment
- With magnet on the head, comfortable

耐油柄螺丝批组套

Screwdriver Set, With Oil Resistant Handle



8PCS(工具箱) Tool Box

货号 Item No	规格 Size	装箱数 Pc/ Carton	毛重 GW/CTN	每套重量 Weight Per Set
M 07601	一字 5x75mm, 6x80mm, 6x100mm, 6x150mm 十字 PH1x75mm, PH2x80mm, PH2x100mm, PH2x150mm	6sets	7.71kg	1.035kg



6PCS(挂袋) Pouch Set

货号 Item No	规格 Size	装箱数 Pc/ Carton	毛重 GW/CTN	每套重量 Weight Per Set
M 07599	十字 Phillips PH0x75mm PH1x100mm PH2x150mm 一字 Slotted 3x75mm 5x100mm 6x150mm	24sets	14.30kg	0.542kg

- 包装坚固耐用，方便携带，采用无毒材料，符合欧盟标准
- 刀杆采用优质S2 加工而成，整体热处理
- 头部带强磁，双色注塑手柄，握感舒适
- 柄部有尾孔方便加力，柄头部有一字或十字标志，方便取用
- Durable packaging, easy to carry, grip with no-toxic material, meet EU standard
- Made of S2, heat treatment
- With magnet on head, comfortable

耐油柄+穿芯 螺丝批

· 多功能

结合部位加力设计，可满足旋、敲、撬等特殊需要



· 坚固

Cr.V-Mo 高级合金钢六角批杆通体制造，硬度高，韧性好，抗冲击强。



· 耐油

TPR+PP 材料手柄，耐 12 种有机溶剂，手感舒适不易断裂



耐油柄穿芯十字螺丝批

Screwdriver Phillips



货号 Item No	规格 Size	装盒数 Pc/Box	装箱数 Pc/ Carton	毛重 GW/CTN	单支重 NW/PC
M 57351	PH2 × 100mm	12pcs	120pcs	22.80kg	0.178kg
M 57352	PH2 × 150mm	12pcs	120pcs	20.60kg	0.158kg
M 57355	PH3 × 200mm	6pcs	72pcs	21.50kg	0.270kg
M 57357	PH3 × 300mm	6pcs	72pcs	23.00kg	1.222kg

- 刀杆采用优质S2 加工而成，整体热处理
- 柄部有尾孔方便加力柄头部有十字标志方便取用
- 头部带强磁双色注塑手柄，手感舒适
- Made of S2, heat treatment
- With magnet on the head, comfortable

耐油柄穿芯一字螺丝批

Screwdriver Slotted



货号 Item No	规格 Size	装盒数 Pc/Box	装箱数 Pc/ Carton	毛重 GW/CTN	单支重 NW/PC
M 57301	6 × 100mm	12pcs	120pcs	22.70kg	0.176kg
M 57302	6 × 150mm	12pcs	120pcs	20.60kg	0.158kg
M 57305	8 × 200mm	6pcs	72pcs	21.30kg	0.270kg
M 57307	8 × 300mm	6pcs	72pcs	25.00kg	0.307kg

- 刀杆采用优质S2 加工而成，整体热处理
- 柄部有尾孔方便加力柄头部有一字标志方便取用
- 头部带强磁双色注塑手柄，手感舒适
- Made of S2, heat treatment
- With magnet on the head, comfortable

8 件冲击螺丝批组套

8pcs impact screwdriver set



明细：
转换接头1个 冲击手柄一个
批头6个：十字 PH1x80mm, PH2x80mm, PH3x80mm, PH3x36mm, 一字 9mmx80mm, 一字8mmx36mm
1 adaptor; 1 impact handle
6 bits: Phillips PH1x80mm, PH2x80mm, PH3x80mm, PH3x36mm, Slotted 9mmx80mm, 一字8mmx36mm

货号 Item No	规格 Size	装盒数 Pc/Box	装箱数 Pc/ Carton	毛重 GW/CTN	每套重量 Weight Per Set
M 07608	8pcs	1set	20sets	18.70kg	0.91kg

- 采用优质钢材制造而成，批头 S2 材质，可调节旋转方向，保证敲击时螺丝松动
- 原套工具配 6 个批头 (S2 材质)
- 主要用于收紧或松脱已锈蚀及顽固螺丝组件，广泛应用于汽车、摩托车、门锁、座位组件及一般家庭机器维修
- △ 本品属于易耗品，不属于终身保用范围
- Made of super steel, bits with S-2, can adjust direction
- △ No warranty as consumables

一字胶柄螺丝批

Screwdriver Slotted



★旧款售完下架，新款将替代上市

货号 Item No	规格 Size	装盒数 Pc/Box	装箱数 Pc/ Carton	毛重 GW/CTN	单支重 NW/PC
M 55032	3 × 75mm	12pcs	144pcs	4.80kg	0.030kg
M 55033	3 × 100mm	12pcs	144pcs	4.80kg	0.030kg
M 55041	4 × 100mm	12pcs	120pcs	7.70kg	0.060kg
M 55051	5 × 100mm	12pcs	120pcs	8.90kg	0.070kg
M 55054	5 × 200mm	12pcs	120pcs	10.10kg	0.080kg
M 55063	6 × 100mm	12pcs	120pcs	12.50kg	0.100kg
M 55064	6 × 125mm	12pcs	120pcs	12.50kg	0.100kg
M 55065	6 × 150mm	12pcs	120pcs	12.00kg	0.090kg
M 55076	8 × 150mm	12pcs	72pcs	11.30kg	0.150kg

- 刀杆采用优质 CrV 钢加工而成，整体热处理
- 头部带强磁双色注塑手柄，手感舒适
- △ 本品属于易耗品，不属于终身保用范围
- Made of CRV, heat treatment · With magnet on the head, comfortable
- △ No warranty as consumables

十字胶柄螺丝批

Screwdriver Phillips



★旧款售完下架，新款将替代上市

货号 Item No	规格 Size	装盒数 Pc/Box	装箱数 Pc/ Carton	毛重 GW/CTN	单支重 NW/PC
M 55093	PH0 × 75	12pcs	144pcs	4.00kg	0.024kg
M 55094	PH0 × 100	12pcs	144pcs	4.10kg	0.024kg
M 55111	PH1 × 100	12pcs	120pcs	8.00kg	0.058kg
M 55114	PH1 × 200	12pcs	120pcs	9.80kg	0.075kg
M 55123	PH2 × 100	12pcs	120pcs	11.00kg	0.080kg
M 55124	PH2 × 125	12pcs	120pcs	12.20kg	0.092kg
M 55125	PH2 × 150	12pcs	120pcs	12.30kg	0.090kg
M 55136	PH3 × 150	12pcs	72pcs	11.00kg	0.139kg

- 刀杆采用优质 CrV 钢加工而成，整体热处理
- 头部带强磁双色注塑手柄，手感舒适
- △ 本品属于易耗品，不属于终身保用范围
- Made of CRV, heat treatment · With magnet on the head, comfortable
- △ No warranty as consumables

8in1 站式螺丝刀组套

8 in 1 Screwdriver Set



十字批头: PH2, PH1, PH0
一字批头: 6mm, 5mm, 3mm
针型批头
勾型批头

货号 Item No	规格 Size	装盒数 Pc/Box	装箱数 Pc/ Carton	毛重 GW/CTN	每套重量 Weight Per Set
M 07610	8合1	6sets	48sets	16.00kg	0.29kg

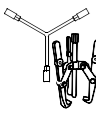
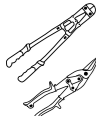
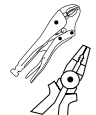

INDEX

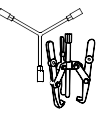
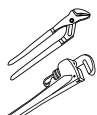
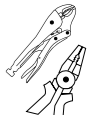

INDEX

精密螺丝批组套
Accurate Screwdriver Set



6PCS

货号 Item No	规格 Size	装盒数 Pc/Box	装箱数 Pc/Carton	毛重 GW/CTN	每套重量 Weight Per Set
M 07603	十字 PH0, PH1, 一字 1.4,2.2,4,3mm	6sets	72sets	16.00kg	0.201kg



4PCS

货号 Item No	规格 Size	装盒数 Pc/Box	装箱数 Pc/Carton	毛重 GW/CTN	每套重量 Weight Per Set
M 07605	十字 PH00, PH0, PH1, 一字 1.4,2.2,4mm	6sets	36sets	3.70kg	0.089kg

- 刀杆采用优质 S2 加工而成，整体热处理
- 头部带强磁双色注塑手柄，手感舒适
- Bits made of S2
- With magnet on the head, comfortable grip

6件精密螺丝批组套
6PCS Accurate Screwdriver Set



货号 Item No	规格 Size	装盒数 Pc/Box	装箱数 Pc/Carton	毛重 GW/CTN	每套重量 Weight Per Set
M 07600	十字 PH0, PH1, 一字 1.4,2.2,4,3mm	48sets	6	6.22kg	0.12kg

米字胶柄螺丝批
Screwdriver Pozidriv



★此款售完下架

货号 Item No	规格 Size	装盒数 Pc/Box	装箱数 Pc/Carton	毛重 GW/CTN	单支重 NW/PC
M 57441	PZ0 x 75	12pcs	144pcs	5.50kg	0.035kg
M 57449	PZ1 x 100	12pcs	144pcs	11.40kg	0.073kg
M 57450	PZ1 x 150	12pcs	144pcs	12.60kg	0.076kg
M 57460	PZ2 x 100	12pcs	120pcs	12.40kg	0.092kg
M 57461	PZ2 x 150	12pcs	120pcs	13.60kg	0.100kg
M 57476	PZ3 x 150	6pcs	96pcs	17.30kg	0.167kg

- 刀杆采用优质 CrV 钢加工而成，整体热处理
- 头部带强磁双色注塑手柄，手感舒适
- 本品属于易耗品，不属于终身保用范围
- Made of CrV, heat treatment
- With magnet on the head, comfortable
- No warranty as consumables

橡塑钢卷尺
ABS Body Tape Measure



货号 Item No	规格 Size	装盒数 Pc/Box	装箱数 Pc/Carton	毛重 GW/CTN	单支重 NW/PC
M 26131	2m x 16mm	12pcs	120pcs	17.00kg	0.130kg
M 26132	3m x 16mm	12pcs	120pcs	19.00kg	0.140kg
M 26133	5m x 19mm	12pcs	120pcs	29.30kg	0.230kg
M 26134	7.5m x 25mm	6pcs	72pcs	31.30kg	0.420kg

- ABS 尺壳，黑色橡胶套，手感舒适，弹性好，尺带韧性好
- 本品属于易耗品，不属于终身保用范围
- ABS shuck, black rubber cover, feel comfortable, good elasticity & toughness
- No warranty as consumables

强磁钢卷尺
Magnetic Tape Measure



货号 Item No	规格 Size	装盒数 Pc/Box	装箱数 Pc/Carton	毛重 GW/CTN	单支重 NW/PC
M 26154	3m x 16mm	12pcs	120pcs	18.50kg	0.142kg
M 26155	5m x 25mm	6pcs	72pcs	23.50kg	0.300kg
M 26156	7.5m x 25mm	6pcs	48pcs	22.50kg	0.437kg

- 25mm x 0.12mm 加宽、加厚尺带，挺度强，适合远距离测量
- 强磁尺钩，可吸住金属物体便于测量，ABS 尺壳，黑色橡胶套，手感舒适
- 本品属于易耗品，不属于终身保用范围
- 25mmx0.12mm tape, extra wide and thick, excellent stiffness, suitable for long distance measuring
- magnetic hook which can attract steel object, ABS shuck, black rubber cover, feel comfortable
- No warranty as consumables

盒式长钢卷尺
Long Measuring Tape



货号 Item No	规格 Size	装盒数 Pc/Box	装箱数 Pc/Carton	毛重 GW/CTN	单支重 NW/PC
M 26184	10m x 12.5mm	1pc	50pcs	17.00kg	0.320kg
M 26185	20m x 12.5mm	1pc	50pcs	15.20kg	0.280kg

- ABS 尺壳，弹性好，尺带韧性好
- 本品属于易耗品，不属于终身保用范围
- ABS plastic shuck, good elasticity and toughness
- No warranty as consumables

双面高档鲁班钢卷尺
Double-sided high-grade Luban steel tape measure



可做厘米尺、鲁班尺、丁兰尺和传统尺使用

货号 Item No	规格 Size	装盒数 Pc/Box	装箱数 Pc/Carton	毛重 GW/CTN	单支重 NW/PC
M 26010	5.0mx19mm	6pcs	72pcs	14.60kg	0.19kg

- 65Mn 钢材尺带，弯折性强
- 全新进口 PC 透明材料制造，透明精美，坚韧耐摔
- 本品属于易耗品，不属于终身保用范围
- 65Mn steel, good flexibility
- Transparent plastic shell, beautiful and strong
- No warranty as consumables

塑壳公制纤维卷尺
Fiber Glass metric tape



货号 Item No	规格 Size	装盒数 Pc/Box	装箱数 Pc/Carton	毛重 GW/CTN	单支重 NW/PC
M 26352	30m	1pc	60pcs	26.60kg	0.417kg
M 26353	50m	1pc	30pcs	21.00kg	0.633kg

- ABS 尺壳，玻璃纤维加厚尺带，无弹性，测量准确
- 本品属于易耗品，不属于终身保用范围
- ABS shuck, thicker glass fiber tape, more accurate measurement.
- No warranty as consumables

双色包胶公制手提钢卷尺
Bi-color plastic shuck tape



货号 Item No	规格 Size	装盒数 Pc/Box	装箱数 Pc/Carton	毛重 GW/CTN	单支重 NW/PC
M 26174	30m	1pc	20pcs	21.70kg	0.92kg
M 26175	50m	1pc	20pcs	31.70kg	1.175kg
M 26176	100m	1pc	10pcs	22.10kg	2.050kg

- ABS 尺壳, 黑色橡胶套, 手感舒适 · 烤漆尺带, 不易生锈
- △ 本品属于易耗品, 不属于终身保用范围
- High strength ABS plastic shuck, painted belt, not easily rusted, black rubber grip
- △ No warranty as consumables

钢架镜面公制手提钢卷尺
Metric Mirror Finish Steel Blade Long Tape



货号 Item No	规格 Size	装盒数 Pc/Box	装箱数 Pc/Carton	毛重 GW/CTN	单支重 NW/PC
M 26168	30m x13mm	1pc	20pcs	23.00kg	1.075kg
M 26169	50m x13mm	1pc	20pcs	30.30kg	1.450kg
M 26170	100m x13mm	1pc	10pcs	24.00kg	2.270kg

- 电镀尺带, 不易生锈
- △ 本品属于易耗品, 不属于终身保用范围
- Chromed belt, not easy rusted
- △ No warranty as consumables

公制钢直尺
Metric Steel ruler



货号 Item No	规格 Size	装盒数 Pc/Box	装箱数 Pc/Carton	毛重 GW/CTN	单支重 NW/PC
M 26425	150mm(6")	10pcs	600pcs	13.00kg	0.022kg
M 26426	300mm(12")	10pcs	300pcs	22.30kg	0.070kg
M 26427	500mm(20")	10pcs	120pcs	15.00kg	0.117kg
M 26428	1000mm(40")	10pcs	60pcs	19.80kg	0.300kg

- 采用优质不锈钢加工而成, 公英制刻度, 方便测量
- △ 本品属于易耗品, 不属于终身保用范围
- Made of super stainless steel, with SAE and metric scale, easy to measure
- △ No warranty as consumables

公制钢拐尺
Metric square

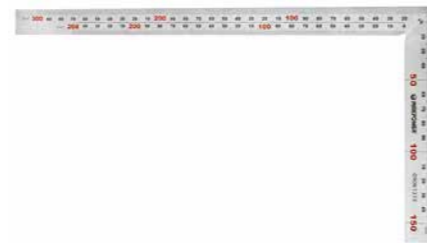

货号 Item No	规格 Size	装盒数 Pc/Box	装箱数 Pc/Carton	毛重 GW/CTN	单支重 NW/PC
M 26451	300 x 150mm(6")	10pcs	100pcs	16.00kg	0.130kg
M 26452	500 x 250mm(10")	10pcs	100pcs	26.60kg	0.235kg

- 采用优质钢加工而成, 公制刻度
- △ 本品属于易耗品, 不属于终身保用范围
- Metric scale
- △ No warranty as consumables

铝合金组合角尺
Aluminium alloy steel square



货号 Item No	规格 Size	装盒数 Pc/Box	装箱数 Pc/Carton	毛重 GW/CTN	单支重 NW/PC
M 26471	300mm(12")	6pcs	60pcs	14.50kg	0.217kg

- 铝合金尺座, 可调节水平, 尺板可滑动
- △ 本品属于易耗品, 不属于终身保用范围
- With zinc alloy steel base, adjustable level, it can be slided
- △ No warranty as consumables

强磁可调角度水平尺
Magnetic Level with Adjustable Vial



货号 Item No	规格 Size	装箱数 Pc/Box	毛重 GW/CTN	单支重 NW/PC
M 26565	400mm(16")	30pcs	8.50kg	0.25kg
M 26567	600mm(24")	30pcs	13.00kg	0.40kg
M 26568	800mm(32")	30pcs	16.50kg	0.50kg
M 26569	1000mm(40")	30pcs	20.20kg	0.68kg

- 铝合金尺架, 带强磁;
- 水平、竖直、可调水泡, 三合一功能, 适用范围广;
- 底面精铣, 保证尺身平整度;
- 可调水泡0~90°, 测量量程广
- △ 本品属于易耗品, 不属于终身保用范围
- Aluminum alloy frame with strong magnetism;
- Three-in-one adjustable horizontal and vertical vial, wide application range;
- Fine milled surface for best flatness of the body;
- 0~90° adjustable vial, wide measurement range
- △ No warranty as consumables

高档塑壳钢卷尺
High-Grade Measuring Tape



★本品售完为止

货号 Item No	规格 Size	装盒数 Pc/Box	装箱数 Pc/Box	毛重 GW/CTN	单支重 NW/PC
M 26112	3.0m x16mm	6pcs	72pcs	8.80kg	0.108kg
M 26113	5.0m x 19mm	6pcs	72pcs	15.30kg	0.199kg
M 26114	5.0m x 25mm	6pcs	72pcs	19.60kg	0.258kg
M 26115	7.5m x 25mm	6pcs	36pcs	13.80kg	0.356kg

- 高强度ABS塑料尺壳, 韧性强, 耐压抗摔
- 尺面经过特殊处理, 无铅烤漆, 高耐磨涂层刻度清晰抗磨损, 表面不反光不刺眼, 不同角度读值清晰. △ 本品属于易耗品, 不属于终身保用范围
- High-impact ABS plastic ruler shell, pressure-proof and crash resistant.
- Specially treated tape lead-free paint, wear resistant scale, anti-glare surface, clear reading from different angles △ No warranty as consumables

带刻度强磁水平尺
Aluminium level with scale



货号 Item No	规格 Size	装箱数 Pc/Box	毛重 GW/CTN	单支重 NW/PC
M 26575	300mm(12")	50pcs	9.30kg	0.170kg
M 26576	400mm(16")	50pcs	10.70kg	0.200kg
M 26577	500mm(20")	50pcs	13.70kg	0.250kg
M 26578	600mm(24")	50pcs	14.00kg	0.280kg
M 26579	800mm(32")	50pcs	18.00kg	0.330kg
M 26580	1000mm(40")	50pcs	20.00kg	0.400kg
M 26581	1200mm(48")	50pcs	29.00kg	0.563kg

- 铝合金尺架, 带强磁;
- 尺架带刻度, 可用于辅助长度测量, 三个水泡可使用于不同角度测量水平
- △ 本品属于易耗品, 不属于终身保用范围
- Zinc alloy steel body, designed with strong magnetism, with sales helpful to measuring length, with 3 bubbles design for different angles measuring
- △ No warranty as consumables

双色包胶铝合金手提钢卷尺
Aluminum tape with bi-color grip



★本品售完为止

货号 Item No	规格 Size	装盒数 Pc/Box	装箱数 Pc/Box	毛重 GW/CTN	单支重 NW/PC
M 26162	30m	1pc	20pcs	18.40kg	0.850kg
M 26163	50m	1pc	20pcs	25.00kg	1.150kg

- 铝合金尺架, 双色包胶手柄, 轻便舒适 · 煮黑烤漆尺带, 不易生锈
- △ 本品属于易耗品, 不属于终身保用范围
- Aluminium alloy steel rack, bi-color comfortable grip, painted belt, not easily rusted.
- △ No warranty as consumables

木柄圆头锤

Wooden Handle Ball Peen Hammer

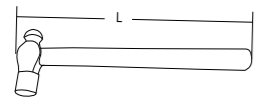

货号 Item No	规格 Size	总长(L) length	装盒数 Pc/Box	装箱数 Pc/Carton	毛重 GW/CTN	单支重 NW/PC
M 24101	0.5LB	280mm	6 pcs	72pcs	23.0kg	0.31 kg
M 24102	0.75LB	310mm	6 pcs	48pcs	21.0kg	0.42 kg
M 24103	1LB	330mm	6 pcs	36pcs	23.0kg	0.61 kg
M 24104	1.5LB	350mm	6 pcs	24pcs	22.0kg	0.88 kg
M 24105	2LB	370mm	6 pcs	24pcs	27.0kg	1.08 kg
M 24106	2.5LB	400mm	6 pcs	18pcs	24.0kg	1.28 kg
M 24107	3LB	400mm	6 pcs	18pcs	26.0kg	1.39 kg

- 锤头采用优质钢材锻造而成，耐冲击
 - 特殊的锤头安全嵌入工艺，保证锤头不脱落
 - 手柄采用缅甸青冈木，韧性佳
- Drop forged with high quality steel, endure being impacted

木柄羊角锤

Wooden Handle Claw Hammer

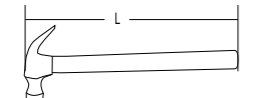

货号 Item No	规格 Size	总长(L) length	装盒数 Pc/Box	装箱数 Pc/Carton	毛重 GW/CTN	单支重 NW/PC
M 24121	8oz	290mm	6pcs	72pcs	29.0kg	0.390kg
M 24122	12oz	330mm	6pcs	36pcs	25.0kg	0.640kg
M 24123	16oz	335mm	6pcs	36pcs	21.0kg	0.830kg
M 24124	20oz	327mm	6pcs	24pcs	29.00kg	1.125kg
M 24125	24oz	330mm	6pcs	24pcs	29.00kg	0.750kg

- 手柄采用缅甸青冈木，韧性佳
 - 锤头采用优质钢材锻造而成，耐冲击
 - 特殊的锤头安全嵌入工艺，保证锤头不脱落
- Drop forged with high quality steel, endure being impacted

木柄八角锤

Wooden Handle Sledge Hammer



货号 Item No	规格 Size	总长(L) length	装盒数 Pc/Box	装箱数 Pc/Carton	毛重 GW/CTN	单支重 NW/PC
M 24141	2LB	300mm	6 pcs	24 pcs	27.0kg	1.08 kg
M 24142	3LB	360mm	6 pcs	12 pcs	20.0kg	1.58 kg
M 24143	4LB	400mm	6 pcs	12 pcs	25.0kg	2.00 kg
M 24144	6LB	800mm	6 pcs	6 pcs	20.0kg	3.17 kg
M 24145	8LB	800mm	4 pcs	4 pcs	17.0kg	4.00 kg
M 24146	10LB	900mm	4 pcs	2 pcs	21.0kg	5.00 kg
M 24147	12LB	900mm	2 pcs	2 pcs	15.0kg	7.25 kg
M 24148	14LB	900mm	2 pcs	2 pcs	15.0kg	7.25 kg
M 24149	16LB	900mm	2 pcs	2 pcs	17.0kg	8.25 kg
M 24150	18LB	900mm	2 pcs	2 pcs	19.0kg	9.00 kg
M 24151	20LB	900mm	2 pcs	2 pcs	20.0kg	9.75 kg

- 手柄采用缅甸青冈木，韧性佳
 - 锤头采用优质钢材锻造而成，耐冲击 · 特殊的锤头安全嵌入工艺，保证锤头不脱落
- Drop forged with high quality steel, endure being impacted

木柄钳工锤

Riveting Hammer With Wooden Handle



货号 Item No	规格 Size	装盒数 Pc/Box	装箱数 Pc/Carton	毛重 GW/CTN	单支重 NW/PC
M 24169	0.2kg	6pcs	72pcs	19.70 kg	0.25 kg
M 24170	0.3kg	6pcs	72pcs	31.60 kg	0.42 kg
M 24171	0.5kg	6pcs	48pcs	30.00 kg	0.57 kg
M 24172	0.8kg	6pcs	24pcs	22.90 kg	0.88 kg
M 24173	1kg	6pcs	24pcs	28.00 kg	1.08 kg
M 24174	1.5kg	6pcs	12pcs	20.20 kg	1.50 kg
M 24175	2kg	6pcs	12pcs	25.10 kg	1.92 kg

- 手柄采用缅甸青冈木，韧性佳
 - 锤头采用优质钢材锻造而成，耐冲击 · 特殊的锤头安全嵌入工艺，保证锤头不脱落
- Drop forged with high quality steel, endure being impacted

木柄锌合金安装锤

Double-Faced Soft Mallet



★售完升级

货号 Item No	规格(Φ) Size	总长 length	装盒数 Pc/Box	装箱数 Pc/Carton	毛重 GW/CTN	单支重 NW/PC
M 24281	22mm	258 mm	6pcs	60pcs	9.00kg	0.12kg
M 24282	45mm	355 mm	6pcs	24pcs	13.00kg	0.46kg

锤头采用优质锌合金铸造，可更换锤头，由软性和硬性锤头选择，适合不同场合。
The hammer head is casted with high quality zinc alloy steel and it is changeable with two kinds of heads-soft and hard which can be used for different places.

无弹力防震锤

Dead Blow Hammer



★售完升级

货号 Item No	规格 Size	总长(L) length	装盒数 Pc/Box	装箱数 Pc/Carton	毛重 GW/CTN	单支重 NW/PC
M 24328	0.5LB	270 mm	6pcs	36pcs	20.00kg	0.500kg
M 24329	1LB	300 mm	6pcs	24pcs	17.00kg	0.643kg
M 24330	1.5LB	324 mm	6pcs	24pcs	22.00kg	0.790kg
M 24331	2LB	350 mm	6pcs	24pcs	24.00kg	0.915kg
M 24332	2.5LB	350 mm	6pcs	24pcs	27.00kg	1.041kg

内部A3钢焊接，外面PVC包塑，耐敲击，防滑，防油，握感舒适，极其适合防火场所的特殊适用条件，锤头内含钢珠敲击不反弹。可重击，绝不伤害工件表面无敲击火花。
The inside is welded A3 steel and coated with PVC outside. It is knock-resistant, anti-slip and grease proof with comfortable grip which is suitable for fire prevention places. The head contains steel ball inside which makes knocking without elastic rebound. It can be used for heavily knocking and never damage the surface of the work piece and also without tapping sparks.

白色橡胶锤

Rubber Mallet

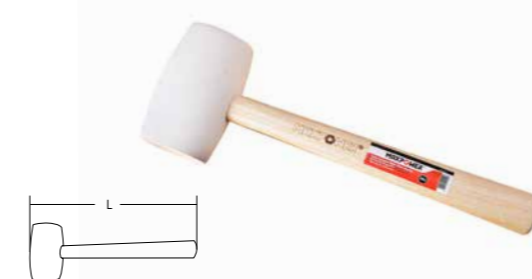

货号 Item No	规格 Size	总长(L) length	装盒数 Pc/Box	装箱数 Pc/Carton	毛重 GW/CTN	单支重 NW/PC
M 24305	8oz	295 mm	6pcs	48pcs	16.80 kg	0.36kg
M 24306	12oz	300 mm	6pcs	48pcs	20.20 kg	0.43kg
M 24307	16oz	340 mm	6pcs	24pcs	25.80 kg	0.60kg
M 24308	24oz	340 mm	6pcs	24pcs	21.50kg	0.83kg
M 24309	32oz	350 mm	6pcs	24pcs	26.20kg	1.02kg

- 锤头采用白色无杂质橡胶制成，弹性、韧性佳、不碎裂
- The hammer head is made of white pure rubber with good flexibility, without any chance to break.

- ✓ 弹性好
- ✓ 韧性佳
- ✓ 不碎裂



包塑柄八角锤

Sledge Hammer With Fiber Handle



货号 Item No	规格 Size	总长(L) length	装盒数 Pc/Box	装箱数 Pc/Carton	毛重 GW/CTN	单支重 NW/PC
M 24258	2LB	335mm	6 pcs	24 pcs	27.00kg	1.08kg
M 24259	3LB	375mm	6 pcs	12 pcs	20.00kg	1.64kg
M 24260	4LB	380mm	6 pcs	12 pcs	25.00kg	2.09kg
M 24261	6LB	875mm	6 pcs	6 pcs	23.00kg	3.68kg
M 24262	8LB	880mm	4 pcs	4 pcs	20.00kg	4.58kg
M 24263	10LB	885mm	4 pcs	2 pcs	21.00kg	5.48kg
M 24264	12LB	890mm	4 pcs	2 pcs	27.00kg	6.38kg
M 24265	14LB	895mm	2 pcs	2 pcs	15.00kg	7.28kg
M 24266	16LB	900mm	2 pcs	2 pcs	16.50kg	8.18kg
M 24267	18LB	905mm	2 pcs	2 pcs	18.50kg	9.08kg
M 24268	20LB	910mm	2 pcs	2 pcs	21.00kg	9.98kg

- 锤头采用优质钢材锻造而成，耐冲击 · 特殊的锤头安全嵌入工艺，保证锤头不脱落
- 手柄采用玻璃纤维柄，韧性佳，外部TPR包胶，手感舒适
- Drop forged with high quality steel, impact resistance

包塑柄羊角锤

Claw Hammer With Fiber Handle



货号 Item No	规格 Size	总长(L) length	装盒数 Pc/Box	装箱数 Pc/Carton	毛重 GW/CTN	单支重 NW/PC
M 24233	8oz	280mm	6pcs	72pcs	28.00kg	0.37kg
M 24234	12oz	340mm	6pcs	36pcs	27.00kg	0.70kg
M 24235	16oz	350mm	6pcs	24pcs	21.00kg	0.84kg
M 24236	20oz	327mm	6pcs	24pcs	31.00kg	1.21kg
M 24237	24oz	330mm	6pcs	24pcs	25.40kg	1.00kg

- 锤头采用优质钢材锻造而成，耐冲击
- 手柄采用玻璃纤维柄，韧性佳，外部TPR包胶，手感舒适
- Drop forged with high quality steel, impact resistance · Fiberglass handle

包塑柄圆头锤

Ball Peen Hammer With Fiber Handle



货号 Item No	规格 Size	总长(L1) length	L2	W1	W2	装盒数 Pc/Box	装箱数 Pc/Carton	毛重 GW/CTN	单支重 NW/PC
M24211	0.5LB	280mm	22mm	76mm	31mm	6 pcs	72pcs	27.00kg	0.36kg
M24212	0.75LB	285mm	27mm	92mm	42mm	6 pcs	48pcs	22.00kg	0.46kg
M24213	1LB	320mm	30mm	100mm	42mm	6 pcs	48pcs	32.00kg	0.65kg
M24214	1.5LB	325mm	31mm	110mm	42mm	6 pcs	36pcs	32.00kg	0.88kg
M24215	2LB	365mm	33mm	122mm	47mm	6 pcs	24pcs	29.00kg	1.19kg
M24216	2.5LB	370mm	38mm	129mm	47mm	6 pcs	12pcs	17.60kg	1.38kg

- 锤头采用优质钢材锻造而成，耐冲击 · 特殊的锤头安全嵌入工艺，保证锤头不脱落
- 手柄采用玻璃纤维柄，韧性佳，外部TPR包胶，手感舒适
- Drop forged with high quality steel, impact resistance

电工墙砖凿
Electrician's Wall Brick Chisel



货号 Item No	规格 Size	装盒数 Pc/Box	装箱数 Pc/Carton	毛重 GW/CTN	单支重 NW/PC
M 24075	100x19x215mm	6pcs	24pcs	15.00kg	0.574kg

材质：60CR-V。主要用于线盒开关的铲平和成型，优点：
1、防震，使用者握着舒服；2、防砸，避免打到施工者本人；
3、砖槽尺寸一步到位，无需再次测量
The product is mainly used for shaping and flattening of groove for line box. The advantages:
1. anti-shock, with comfortable gripping.
2. anti-hurting, avoid from hurting the user
3. the groove size is achieved by one step, no need to measure again.

胶柄扁凿
Flat Chisel With Plastic Handle



货号 Item No	规格 Size	装盒数 Pc/Box	装箱数 Pc/Carton	毛重 GW/CTN	单支重 NW/PC
M 24053	25x19x300mm	6pcs	24pcs	20.50kg	0.78kg

材质：60CR-V。主要用于机械维修、安装、建筑、汽修、岩石混凝土工程等行业，主要是开槽、雕刻、打焊渣、清键槽等维修工作。优点：
1、防震，使用者握着舒服；2、防砸，避免打到施工者本人
The product is mainly used in fields of mechanical repair, assembling, construction, automobile service, rock and concrete work and used for slotting, engraving, removing welding slag and cleaning key groove, etc.

工业级扁凿
Cold Chisel



货号 Item No	规格 Size	产品编号 Product No	总长 length	装盒数 Pc/Box	装箱数 Pc/Carton	毛重 GW/CTN	单支重 NW/PC
M 24045	160mm(6")	WZ0106	160mm	6pcs	72pcs	14.3kg	0.19kg
M 24046	200mm(8")	WZ0108	200mm	6pcs	60pcs	19.6kg	0.31kg
M 24047	250mm(10")	WZ0110	250mm	6pcs	36pcs	17.3kg	0.46kg
M 24048	300mm(12")	WZ0112	300mm	6pcs	24pcs	14.8kg	0.57kg

· 整支锻造，高频淬火，发黑处理，两次热处理，不塌刃
△ 本品属于易耗品，不属于终身保用范围
· Drop forged, high frequency heat-treated, black phosphated
△ No warranty as consumables

胶柄尖凿
Point Chisel With Plastic Handle



货号 Item No	规格 Size	装盒数 Pc/Box	装箱数 Pc/Carton	毛重 GW/CTN	单支重 NW/PC
M 24054	4x19x300mm	6pcs	24pcs	19.20kg	0.744kg

材质：60CR-V。主要用于机械维修、安装、建筑、汽修、岩石混凝土工程等行业，主要是开槽、雕刻、打焊渣、清键槽等维修工作。优点：
1、防震，使用者握着舒服；2、防砸，避免打到施工者本人
The product is mainly used in fields of mechanical repair, assembling, construction, automobile service, rock and concrete work and used for slotting, engraving, removing welding slag and cleaning key groove, etc.

八角钢三角冲
Cape Chisel

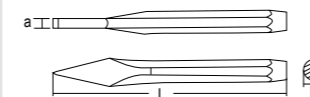

货号 Item No	规格 Size	L	a	b	单支重 NW/PC
M 24627	5×9.5×130mm	130mm	5mm	9.5mm	0.060kg

材质：60CR-V

八角钢扁凿(电镀)
Octagonal Steel Cold Chisel



货号 Item No	规格 Size	L	a	b	单支重 NW/PC
M 24067	12×9.5×130mm	130mm	12mm	9.5mm	0.200kg
M 24068	15×12×150mm	150mm	15mm	12mm	0.125kg
M 24069	18×14×175mm	175mm	18mm	14mm	0.065kg

材质：60CR-V

八角钢中心冲
Center Punch



货号 Item No	规格 Size	L	a	b	单支重 NW/PC
M 24614	4×9.5×120mm	120mm	4mm	9.5mm	0.115kg
M 24615	5×12×150mm	150mm	5mm	12mm	0.055kg

材质：60CR-V

八角钢扁凿
Octagonal Steel Cold Chisel



货号 Item No	规格 Size	L	a	b	单支重 NW/PC
M 24064	20x16x200mm	200mm	20mm	16mm	0.306kg
M 24065	22x20x250mm	250mm	22mm	20mm	0.590kg
M 24066	25x22x300mm	300mm	25mm	22mm	0.864kg

3PCS套装

货号 Item No	规格 Size	装盒数 Pc/Box	装箱数 Pc/Carton	毛重 GW/CTN	每套重量 Weight Per Set
M 07757	3pcs	1set	6sets	11.70kg	1.750kg

产品明细：
扁凿：20X16X200MM, 22X20X250MM, 25X22X300MM
材质：60CR-V

八角钢圆锥冲
Taper Punch



货号 Item No	规格 Size	L	a	b	装盒数 Pc/Box	单支重 NW/PC
M 24621	3×9.5×120mm	120mm	3mm	9.5mm	10pcs	0.055kg

材质：60CR-V

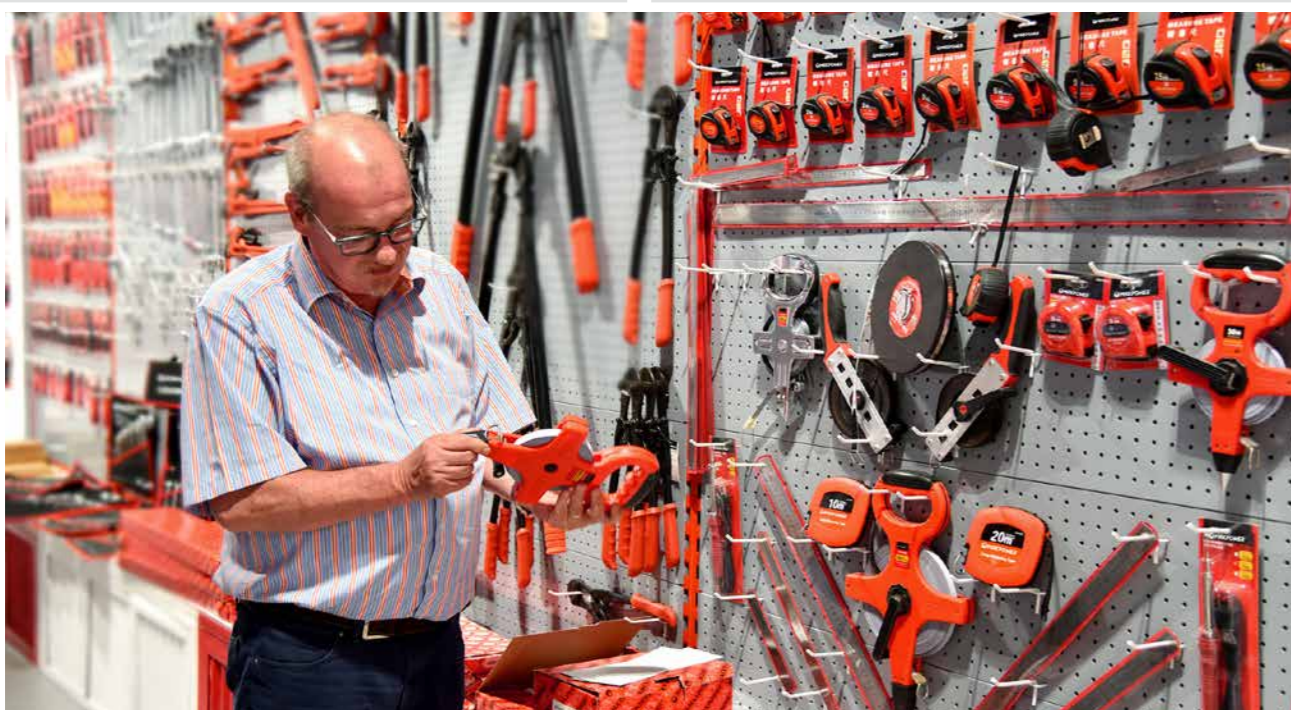



钢样冲组套

Octagonal Steel Punch Set



货号 Item No	规格 Size	装盒数 Pc/Box	装箱数 Pc/Carton	毛重 GW/CTN	每套重量 Weight Per Set
M 07759	5pcs	4sets	40sets	14.00kg	0.313kg

产品明细：
扁凿：12×9.5×130MM 三角凿：5×9.5×130MM
圆柱冲：4×9.5×150MM 圆锥冲：3×9.5×120MM
中心冲：4×9.5×120MM
材质：60CR-V

钢样冲组套

Octagonal Steel Punch Set



货号 Item No	规格 Size	装盒数 Pc/Box	装箱数 Pc/Carton	毛重 GW/CTN	每套重量 Weight Per Set
M 07760	6pcs	1set	20sets	16.50kg	0.750kg

产品明细：
圆柱冲：2×9.5×150MM, 3×9.5×150MM, 4×9.5×150MM,
5×9.5×150MM, 6×12×150MM, 8×12×150MM
材质：60CR-V

八角钢圆柱冲

Pin Punch



货号 Item No	规格 Size	L	a	b	单支重 NW/PC
M 24633	2×9.5×150mm	150mm	2mm	9.5mm	0.055kg
M 24634	3×9.5×150mm	150mm	3mm	9.5mm	0.055kg
M 24635	4×9.5×150mm	150mm	4mm	9.5mm	0.105kg
M 24636	5×9.5×150mm	150mm	5mm	9.5mm	0.095kg
M 24637	6×12×150mm	150mm	6mm	12mm	0.060kg
M 24638	8×12×150mm	150mm	8mm	12mm	0.060kg

材质：60CR-V



电子类、绝缘类工具

Electrical Tools/Insulation Type Tools

电子类	Electrical Tool	
电讯组套	118-119 Electrical Tool Set	118-119
测电笔	120 Voltage Tester	120
压线钳	121-122 Voltage Tester	121-122
剥线钳	122 Wire Stripper	122
电工剪	122 Electrician Scissors	122
电工刀	123 Electrician Knife	123
电烙铁及配件	123 Soldering Iron and Accessories	123
工作灯	123 Working Light	123
绝缘类	Insulation Type Tools	
绝缘组套	124-125 Insulated Tool set	124-125
绝缘钳子	126 Insulated Pliers	126
绝缘扳手	126-127 Insulated Wrench	126-127
绝缘螺丝批	128 Insulated Screwdriver	128
绝缘刀	129 Insulated Knife	129
绝缘电缆剪	129-130 Insulated Cable Cutter	129-130



68 件电讯工具组套

68PCS. Electrician's Tool Set

CR-V



货号 Item No	规格 Size	装箱数 Pc/Box	毛重 GW/CTN	每套重量 Weight Per Set
M 07307	68pcs	4sets	18.50kg	4.25kg

- 1 件 30w 电烙铁 ● 1 件电烙铁架 ● 1 件吸锡器
- 1 件数显测电笔 ● 1 件数显万用表 ● 1 件多功能压接剥线钳
- 1 件美工刀 (带刀片两片) ● 1 件钢卷尺 2M
- 1 件沾塑活扳手 200mm ● 1 件钢丝钳 175mm
- 1 件尖嘴钳 160mm ● 1 件斜嘴钳 160mm
- 6 件螺旋电讯表批 十字 PH0, 1 一字 1.4, 1.8, 2.4, 3.0mm
- 1 件镊子 150mm ● 1 件四用电工刀 ● 1 件 6.3mm 系列旋柄
- 1 件 6.3mm 系列旋具头接头
- 12 件 6.3mm 系列公制套筒 4, 4.5, 5, 5.5, 6, 7, 8, 9, 10, 11, 12, 13mm
- 5 件一字螺丝批 3mm x 75mm, 3mm x 150mm, 3mm x 200mm, 6mm x 100mm, 6mm x 150mm
- 5 件十字螺丝批 PH0 x 75mm, PH0 x 150mm, PH0 x 200mm, PH2 x 100mm, PH2 x 150mm
- 24 件 6.3mm 系列 25mm 长旋具头 十字 PH0, PH1, PH2, PH3 一字 SL3, SL4, SL5, SL6 米字 PZ0, PZ1, PZ2, PZ3 六角 H3, H4, H5, H6 花型 T15, T20, T25, T30 四方 S0, S1, S2, S3
- 1pc Soldering Iron 30w ● 1pc Solder Stand
- 1pc Solder Absorber ● 1pc Digital Voltage Detection Instrument
- 1pc Digital Multimeter
- 1pc Multi-function Cutter Stripper
- 1pc Utility Knife (With Two Blades)
- 1pc 2-metre Tape Measure
- 1pc Adjustable Wrench With Dipped Grip 8"
- 1pc Lineman's Pliers 7" ● 1pc Long Nose Pliers 6"
- 1pc Diagonal Pliers 6"
- 6pcs Electronic Clock Bits Philips PH0, PH1 Slotted 1.4, 1.8, 2.4, 3.0mm
- 1pc 150mm Tweezer ● 1pc 4-function Electrician's Knife
- 1pc Spinner Handle 1/4" Dr. ● 1pc Bit Adapter 1/4" Dr.
- 12pcs 1/4" Dr. metric Socket 4, 4.5, 5, 5.5, 6, 7, 8, 9, 10, 11, 12, 13mm
- 5pcs Philips Screwdrivers PH0 x 75mm, PH0 x 150mm, PH0 x 200mm, PH2 x 100mm, PH2 x 150mm
- 5pcs Slotted Screwdrivers 3mm x 75mm, 3mm x 150mm, 3mm x 200mm, 6mm x 100mm, 6mm x 150mm
- 24pcs 1/4" Shank 25L Bits Philips PH0, PH1, PH2, PH3 Slotted SL3, SL4, SL5, SL6 Pozidriv PZ0, PZ1, PZ2, PZ3 Hex H3, H4, H5, H6 Torx T15, T20, T25, T30 Square S0, S1, S2, S3

△ 工具空盒不属于终身保用范围, 盒内所配置的单支产品请参照单支工具的保用条款
△ The set box is not covered by our lifetime warranty. For single product configured in the box, please refer to the single tool warranty terms.

40 件电讯工具组套

40PCS. Electrician's Tool Set



货号 Item No	规格 Size	装箱数 Pc/Box	装箱数 Pc/Box	毛重 GW/CTN	每套重量 Weight Per Set
M 07306	40pcs	1set	4sets	11.50kg	2.50kg

- 1 件迷你尖嘴钳 115mm
- 1 件迷你斜嘴钳 115mm
- 1 件一字胶柄螺丝批 3mm x 75mm
- 1 件十字胶柄螺丝批 PH0 x 75mm
- 1 件一字胶柄螺丝批 6mm x 100mm
- 1 件十字胶柄螺丝批 PH2 x 100mm
- 8 件平头内六角组套 1.5, 2, 2.5, 3, 4, 5, 5.5, 6mm
- 1 件外热式电烙铁 30W
- 1 件手动吸锡器
- 1 件筒装焊锡丝 17g
- 1 件剥线钳 175mm
- 1 件尖头不锈钢镊子
- 1 件弯头不锈钢镊子
- 1 件数显测电笔
- 1 件电工胶带
- 1 件木柄弧刃电工刀
- 1 件数显万用表
- 1 件焊锡膏
- 1 件烙铁架
- 12 件 6.3mm 系列短套筒 4, 4.5, 5, 5.5, 6, 7, 8, 9, 10, 11, 12, 13mm
- 1 件 6.3mm 系列快调棘轮扳手
- 1 件活扳手 150mm
- 1pc Mini Long Nose Pliers 4.5"
- 1pc Mini Lineman's Pliers 4.5"
- 2pcs Slotted Screwdrivers 3mm x 75mm, 6mm x 100mm
- 2pcs Philips Screwdrivers PH0 x 75mm, PH2 x 100mm
- 8pcs Hex Key Set 1.5, 2, 2.5, 3, 4, 5, 5.5, 6mm
- 1pc Soldering Iron 30w
- 1pc Solder Absorber
- 1pc Solder wire 17g
- 1pc Wire Stripper 6.5"
- 1pc Elbow Tweezer
- 1pc Tip Tweezer
- 1pc Digital Neon-electroscope
- 1pc Electrical Tape
- 1pc Electrician's Knife
- 1pc Digital Multimeter
- 1pc solder paste
- 1pc Solder Stand
- 12pcs 1/4" Dr. Sockets 4, 4.5, 5, 5.5, 6, 7, 8, 9, 10, 11, 12, 13mm
- 1pc Adjustable Wrench 6"

△ 工具空盒不属于终身保用范围, 盒内所配置的单支产品请参照单支工具的保用条款
△ The set box is not covered by our lifetime warranty. For single product configured in the box, please refer to the single tool warranty terms.

32 件电讯工具组套

32PCS. Electrician's Tool Set



货号 Item No	规格 Size	装箱数 Pc/Box	装箱数 Pc/Box	毛重 GW/CTN	每套重量 Weight Per Set
M 07305	32pcs	1set	4sets	15.80kg	3.625kg

- 1 件数显万用表
- 1 件斜嘴钳 160mm
- 1 件卷尺 3m
- 1 件尖嘴钳 160mm
- 10 件内六角组套 2, 2.5, 3, 4, 5, 5.5, 6, 7, 8, 10mm
- 1 件一字胶柄螺丝批 6mm x 100mm
- 1 件十字胶柄螺丝批 PH2 x 100mm
- 1 件一字胶柄螺丝批 3mm x 150mm
- 1 件十字胶柄螺丝批 PH0 x 150mm
- 1 件数显测电笔
- 1 件迷你充电手电筒
- 1 件木柄弧刃电工刀
- 1 件带刃剥线钳 175mm
- 1 件焊锡盒
- 1 件筒装焊锡丝 17g
- 1 件外热式电烙铁 30W
- 1 件烙铁架
- 1 件手动吸锡器
- 1 件弯头不锈钢镊子
- 1 件尖头不锈钢镊子
- 1 件鲤鱼钳 200mm
- 1 件活扳手 200mm
- 1 件工业级直口塑柄大力钳 178mm
- 1pc Digital Multimeter
- 1pc 3-metre Tape Measure
- Long Nose Pliers 6"
- Diagonal Cutting Pliers 6"
- 10pcs Hex Key Set 2, 2.5, 3, 4, 5, 5.5, 6, 7, 8, 10mm
- 2pcs Slotted Screwdrivers 3mm x 150mm, 6mm x 100mm
- 2pcs Philips Screwdrivers PH0 x 150mm, PH2 x 100mm
- 1pc Digital Neon-electroscope
- 1pc Mini Rechargeable Flashlight
- 1pc Electrician's Knife
- 1pc Wire Stripper 6.5"
- 1pc solder paste Box
- 1pc Solder wire 17g
- 1pc Soldering Iron 30w
- 1pc Solder Stand
- 1pc Straight Jaw Locking Pliers with TPR Handle 7" - Industrial Grade
- 1pc Solder Absorber
- 1pc Elbow Tweezer
- 1pc Tip Tweezer
- 1pc Slip Joint Pliers 8"
- 1pc Adjustable Wrench 8"

△ 工具空盒不属于终身保用范围, 盒内所配置的单支产品请参照单支工具的保用条款
△ The set box is not covered by our lifetime warranty. For single product configured in the box, please refer to the single tool warranty terms.

21 件电讯工具组套

21PCS. Electrician's Tool Set



货号 Item No	规格 Size	装箱数 Pc/Box	装箱数 Pc/Box	毛重 GW/CTN	每套重量 Weight Per Set
M 07303	21pcs	1set	8sets	17.80kg	2.15kg

- 1 件数显万用表
- 1 件 3 米钢卷尺
- 1 件尖嘴钳 160mm
- 1 件斜嘴钳 160mm
- 1 件 6 寸钢丝钳
- 7 件球头内六角扳手
- 2 件一字螺丝批 3x75mm 6x100mm
- 2 件十字螺丝批 PH0x75mm PH2x100mm
- 1pc Digital Multimeter
- 1pc 3-metre Tape Measure
- 1pc Long Nose Pliers 6"
- 1pc Diagonal Cutting Pliers 6"
- 1pc Combination Pliers 6"
- 7pcs Hex Key Set
- 2pcs Slotted Screwdrivers (3mm x 75mm, 6mm x 100mm)
- 2pcs Philips Screwdrivers (PH0 x 75mm, PH2 x 100mm)
- 1 件测电笔
- 1 件美工刀
- 1 件铝合金手电筒
- 1 件电工胶带
- 1 件 6 寸防静电板手
- 1pc Digital Neon-electroscope
- 1pc Utility Knife
- 1pc Flashlight
- 1pc Electrical Tape
- 1pc Adjustable Wrench 6"

△ 工具空盒不属于终身保用范围, 盒内所配置的单支产品请参照单支工具的保用条款
△ The set box is not covered by our lifetime warranty. For single product configured in the box, please refer to the single tool warranty terms.

19 件电讯工具组套

19PCS. Electrician's Tool Set



货号 Item No	规格 Size	装箱数 Pc/Box	装箱数 Pc/Box	毛重 GW/CTN	每套重量 Weight Per Set
M 07301	19pcs	1set	8sets	13.70kg	1.563kg

- 1 件沾塑活扳手 150mm
- 1 件迷你尖嘴钳 115mm
- 1 件迷你斜嘴钳 115mm
- 1 件一字胶柄螺丝批 3mm x 75mm
- 1 件一字胶柄螺丝批 6mm x 100mm
- 1 件十字胶柄螺丝批 PH0 x 75mm
- 1 件十字胶柄螺丝批 PH2 x 100mm
- 1 件数显测电笔
- 1 件美工刀
- 1 件十字微型螺丝批 PH00x75mm
- 1 件卷尺 3m
- 1 件不锈钢剪刀
- 1 件焊锡膏
- 1 件烙铁架
- 1 件外热式电烙铁 30W
- 1 件手动吸锡器
- 1 件筒装焊锡丝 17g
- 1 件尖头不锈钢镊子
- 1 件一字微型螺丝批 2mm x 75mm
- 1pc Utility Knife
- 1pc 3-metre Tape Measure
- 1pc Stainless Scissors
- 1pc solder paste
- 1pc Soldering Iron 30w
- 1pc Solder Absorber
- 1pc Solder wire 17g
- 1pc Tip Tweezer 6"
- 1pc Solder Stand

△ 工具空盒不属于终身保用范围, 盒内所配置的单支产品请参照单支工具的保用条款
△ The set box is not covered by our lifetime warranty. For single product configured in the box, please refer to the single tool warranty terms.

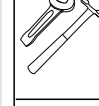
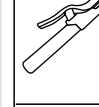
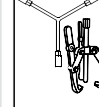
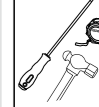
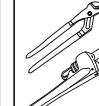
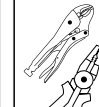
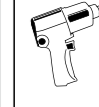
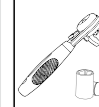
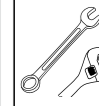
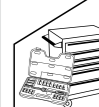
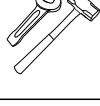
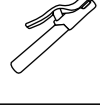
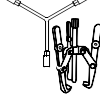
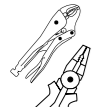

数显万用表
Digital Multimeter



货号 Item No	装盒数 Pc/Box	装箱数 Pc/ Carton	毛重 GW/CTN	单支重 NW/PC
M 64231	1PC	24pcs	6.0kg	0.18kg

二极管、三极管与通断测试，坚固安全可靠，全量程过载保护

最大显示：1999个计数（3 1/2位）带自动极性显示

显示方式：液晶显示屏

过量程指示：只有“OL”显示在液晶屏上

采样速率：2~3次/秒（近似值）

操作温度：0℃~40℃，相对湿度：<75%

存储温度：-10℃~50℃，相对湿度：<85%

电 源：1.5VX3, AAA

低电池指示：“”显示在液晶屏上

尺 寸：158 X 75 X 35 mm

重 量：约200克（含电池）

直流电压DC voltage

量程 measuring range	分辨率 resolution	精度 accuracy
200mV	0.1mV	
2V	0.001V	±(0.8%+5)
20V	0.01V	
200V	0.1V	
600V	1V	±(1%+5)

电阻 resistance

量程 measuring range	分辨率 resolution	精度 accuracy
200Ω	0.1Ω	±(1.2%+5)
2kΩ	0.001kΩ	
20kΩ	0.01kΩ	±(1%+5)
200kΩ	0.1kΩ	
2MΩ	0.001MΩ	±(1.2%+5)
20MΩ	0.01MΩ	±(1.5%+10)

交流电压 AC voltage

量程 measuring range	分辨率 resolution	精度 accuracy
2V	0.001V	
20V	0.01V	±(1.0%+5)
200V	0.1V	
600V	1V	±(1.2%+5)

交流电流 AC current

量程 measuring range	分辨率 resolution	精度 accuracy
200μA	0.1μA	
2000μA	1μA	±(1.5%+5)
20mA	0.01mA	
200mA	0.1mA	
2A	0.001A	±(3.0%+10)
10A	0.01A	

直流电流 DC current

量程 measuring range	分辨率 resolution	精度 accuracy
200μA	0.1μA	
2000μA	1μA	±(1.2%+5)
20mA	0.01mA	
200mA	0.1mA	
2A	0.001A	±(2.0%+10)
10A	0.01A	

交流电压 AC voltage

量程 measuring range	分辨率 resolution	精度 accuracy
2V	0.001V	
20V	0.01V	±(1.0%+5)
200V	0.1V	
600V	1V	±(1.2%+5)

电池测试 battery test

量程 measuring range	分辨率 resolution	精度 accuracy
1.5V	0.01V	
3V	0.01V	显示电池电压的近似值
9V	0.01V	

数显测电笔
Digital Voltage Tester



货号 Item No	规格 Size	装盒数 Pc/Box	装箱数 Pc/ Carton	毛重 GW/CTN	单支重 NW/PC
M 64261	3.5 × 140mm(5")	12pcs	192pcs	11.20kg	0.043kg

- 数显带灯多功能测电笔刀杆采用优质铬钒钢制造，整体淬火，结实耐用
- Multi-use digital tester with lamp, the body is made of Cr-V steel, heat-treated for durable use

非接触式测电笔
Non-Contact Voltage Tester



货号 Item No	规格 Size	装盒数 Pc/Box	装箱数 Pc/ Carton	毛重 GW/CTN	单支重 NW/PC
M64270	5" (140mm)	12pcs	96pcs	7.20kg	0.03kg

自 检:
旋转尾部开关至“”位置，头部绿灯亮起，表示测电笔正常运作（使用前请靠近带电物体测试）。
感应测电:当检测到附近有电场时，绿灯会转为红灯，同时蜂鸣声会响起。
通断测试:旋转尾部开关至“”位置，头部绿灯亮起，电笔靠近电线绿灯转为红灯，同时发出蜂鸣声，表明电源线通电，电笔沿通电电源线移动，由红灯转为绿灯，则此处电路断开。
辅助照明:旋转尾部开关至“”位置，头部绿灯与照明灯同时亮起，既可检测电场又可起到照明作用。
Self test:
Turn the tail switch to the “” position, the green light on the head lights up, indicating that the test pen is operating normally (please test near a charged object before use)
Induction measurement:
When an electric field is detected nearby, the green light will turn to red and the buzzer will sound
Circuit test:
Turn the tail switch to the “” position, the green light on the head lights up, the green light turns to a red light when the electric pen is close to the wire, and a buzzer sounds at the same time, indicating that the power cord is energized, move the electric pen along the energized power line, when the light turns from red to green, then here the broken point
Auxiliary lighting:
Turn the tail switch to the “” position, the green light and the illumination light will be turned on at the same time, which can detect the electric field and illuminate

塑柄测电笔
Voltage Tester



货号 Item No	规格 Size	装盒数 Pc/Box	装箱数 Pc/ Carton	毛重 GW/CTN	单支重 NW/PC
M 64263	3 × 145mm(5")	30pcs	600pcs	15.00kg	0.020kg
M 64264	4 × 190mm(7")	24pcs	480pcs	16.10kg	0.025kg

- ABS 新材料，刀杆整支热处理，测量范围：100~500V
- 可测试 100V~500V 交流电，直接氖灯显示，操作简单
- 绝缘级工程塑料壳体，壳体透明度高，造型美观，手感舒适
- Insulated ABS plastic handle, test range: 100~500V
- △ 本品属于易耗品，不属于终身保用范围
- △ No warranty as consumables

矿用测电笔
Anti-flare High Voltage Electric Tester



货号 Item No	规格 Size	装盒数 Pc/Box	装箱数 Pc/ Carton	毛重 GW/CTN	单支重 NW/PC
M 64299	3.5X145mm(5")	30pcs	240pcs	13.70kg	0.05kg

- 测量范围:AC380-2000V
- 防击穿耐压:AC2500V≥5秒
- 产品特点:专业防爆、防水、矿用高压测电笔
- 整体造型美观，结实耐用，安全系数高，专业级品质
- 精美塑盒包装，安全收纳，携带方便，美观实用
- Testing Range: AC380-2000V
- Anti-breakdown Voltage: AC2500V ≥ 5 seconds
- High voltage glass glaze resistor
- Professional explosion-proof, waterproof, mining high voltage test pen
- The overall shape is beautiful, strong and durable, high factor of safety, professional quality
- Exquisite plastic box packaging, safe storage easy to carry, beautiful and practical

三用网络压线钳
Modular Plug Crimping Tool



货号 Item No	规格 Size	装盒数 Pc/Box	装箱数 Pc/ Carton	毛重 GW/CTN	单支重 NW/PC
M 64143	4-6-8P	6pcs	48pcs	21.2kg	0.41kg

- 多用压线钳，可用于 4 芯、6 芯、8 芯端子的压接
- 根据水晶头的大小 (8P6P4P) 选择压线口的配套规格 · 带有剪线和剥线功能
- △ 本品属于易耗品，不属于终身保用范围
- △ Multi-function, for 4p-6p-8p
- △ No warranty as consumables

网络压线钳
Modular Plug Crimping Tool



货号 Item No	规格 Size	装盒数 Pc/Box	装箱数 Pc/ Carton	毛重 GW/CTN	单支重 NW/PC
M 64142	8p	6pcs	48pcs	15.60kg	0.292kg

- 采用优质钢材制造而成，65Mn 刀片，快捷方便
- 专业适用于各种电脑、电话连接的水晶头的接线压线用
- 根据水晶头的大小 (8P6P4P) 选择压线口的配套规格 · 带有剪线和剥线功能
- △ 本品属于易耗品，不属于终身保用范围
- △ made of high grade steel, 65Mn blades
- △ Suitable for plugs of computers and telephones
- To choose correct size 8p-6p-4p, with function of cutter and stripper
- △ No warranty as consumables

自调式欧式端子压线钳
Self-adjustable Crimping Pliers



货号 Item No	规格 Size	装盒数 Pc/Box	装箱数 Pc/ Carton	毛重 GW/CTN	单支重 NW/PC
M64155	175mm	10pcs	50pcs	23.00kg	0.44kg

- 高精端子压接钳，适度压紧端子于电线上不损端子
- 手柄符合人体工学设计，手感舒适方便操作
- 具有省力棘轮装置，操作轻松，压接效果明确
- 自动调整压线尺寸，不会因为使用不匹配压模而导致错误压接，压后成四方形柱状
- 体积小，操作简单，具有压力调节按钮和棘轮强迫释放按钮，确保产品使用寿命与效能
- High-precision terminal crimping pliers, moderately press the terminal on the wire without damaging the terminal.
- Ergonomic handle, comfortable and easy to operate.
- Labor-saving ratchet design for easy operation and clear crimping effect.
- Automatically adjust the crimp size to avoid incorrect crimping due to the use of mismatched die, and it will become a quadrilateral column after crimping.
- Small size, simple operation, with pressure adjustment button and ratchet forced release button to ensure product life and effectiveness.

C42610A型压线钳
Modular Plug Crimping Tool



货号 Item No	规格 Size	装盒数 Pc/Box	装箱数 Pc/ Carton	毛重 GW/CTN	单支重 NW/PC
M 64149	175mm	1pc	36pcs	0.40kg	
M 64150	230mm	1pc	24pcs	0.61kg	

线径面积:0.14-6.0mm²
应用范围:适用于高铁、动车、轨道交通等回转触头的压接，操作简单方便，省时省力，性能稳定

货号 Item No	总长 length	装盒数 Pc/Box	装箱数 Pc/ Carton	毛重 GW/CTN	单支重 NW/PC
M 64149	175mm	1pc	36pcs	0.40kg	
M 64150	230mm	1pc	24pcs	0.61kg	



▲ 回转触头压接，线径 0.14-6mm² ▲ 压接深度读数窗口 ▲ 旋钮式精密调节装置



▲ 压接深度读数窗口 ▲ 旋钮式精密调节装置

自动剥线钳
Auto Wire Stripper



货号 Item No	规格 Size	装盒数 Pc/Box	装箱数 Pc/ Carton	毛重 GW/CTN	单支重 NW/PC
M 64120	7"(1-3.2mm)	6pcs	48pcs	21.30kg	0.333kg

- 铝合金钳体，65Mn 刀片，快捷方便
- △ 本品属于易耗品，不属于终身保用范围
- Zinc alloy steel body, 65mn blades
- △ No warranty as consumables

棘轮式端子压接钳
Modular Plug Crimping Tool



应用范围:压线帽、绝缘端子、管状绝缘端子等
压接范围: 0.5/1/1.5/2.5/4/6/10mm²

货号 Item No	规格 Size	装盒数 Pc/Box	装箱数 Pc/ Carton	毛重 GW/CTN	单支重 NW/PC
M 64163	9"(230mm)	6pcs	36pcs	22.00kg	0.55kg



应用范围:适用于扁口类端子等
压接范围:0.5-1.5mm² 20-16AWG

货号 Item No	规格 Size	装盒数 Pc/Box	装箱数 Pc/ Carton	毛重 GW/CTN	单支重 NW/PC
M 64162	9"(230mm)	6pcs	36pcs	22.00kg	0.55kg



应用范围:压线帽、绝缘端子、管状绝缘端子等
压接范围: 0.5/1/1.5/2.5/4/6mm²

货号 Item No	规格 Size	装盒数 Pc/Box	装箱数 Pc/ Carton	毛重 GW/CTN	单支重 NW/PC
M 64160	8"(200mm)	6pcs	48pcs	21.00kg	0.39kg



应用范围:监控视频BNC端口等
压接范围: 1.7/2.5/5.4/6.4/8.2mm²

货号 Item No	规格 Size	装盒数 Pc/Box	装箱数 Pc/ Carton	毛重 GW/CTN	单支重 NW/PC
M 64161	9"(245mm)	6pcs	36pcs	23.00kg	0.58kg



- 模头采用合金钢锻造可拆卸更换
- 压板采用50#高碳钢制造, 坚固耐用, 不易弯曲变形
- 牵头棘轮省力连杆装置, 操作省力轻松
- 高精端子压接孔压接精准, 压接一步到位
- 压力调整按钮设计, 方便各种端子使用
- 人体工程学包胶手柄, 握持舒适、防滑耐磨
- The die is forged with alloy steel and can be removed and replaced.
- The pressure plate is made of 50# high carbon steel plate, which is firm and durable, and it is not easy to bend and deform.
- Leading ratchet labor saving linkage device, the operation is easy and effortless.
- High-precision terminal crimping hole, precision crimping, crimping one step in place.
- Pressure adjustment knob design, easy to be used for a variety of terminals.
- Ergonomic plastic handle, comfortable grip, non-slip and wear-resistant.

剥线钳
Wire Stripper



剥线范围:0.6,0.8,1.1,1.3,1.6,2.2,6mm

货号 Item No	规格 Size	装盒数 Pc/Box	装箱数 Pc/ Carton	毛重 GW/CTN	单支重 NW/PC
M 64107	175mm(7")	6pcs	96pcs	17.00kg	0.161kg

- 带锁式, 表面电泳处理, 美观大方
- 采用优质钢材制造而成, 整体热处理
- △ 本品属于易耗品, 不属于终身保用范围
- With lock, drop forged with high grade steel, heat treated.
- △ No warranty as consumables

电工剪
Electrician Scissors



货号 Item No	规格 Size	装盒数 Pc/Box	装箱数 Pc/ Carton	毛重 GW/CTN	单支重 NW/PC
M 64546	145mm(5")	6pcs	144pcs	16.20kg	0.104kg

- 采用优质不锈钢制造, 整支热处理· 刃口锋利, 耐用
- △ 本品属于易耗品, 不属于终身保用范围
- Made of superior stainless steel, heat treated, sharp blades, durable
- △ No warranty as consumables

木柄四用电工刀
Electrician's Knife



货号 Item No	总长(L) length	装盒数 Pc/Box	装箱数 Pc/ Carton	毛重 GW/CTN	单支重 NW/PC
M 64538	115mm	6pcs	120pcs	22.80kg	0.175kg

- CRV 刀片, 优质红木手柄, 锋利耐用
- △ 本品属于易耗品, 不属于终身保用范围
- CRV blade, sharp and durable, with wood handle
- △ No warranty as consumables

木柄弧刃电工刀
Electrician's Knife



货号 Item No	总长(L) length	装盒数 Pc/Box	装箱数 Pc/ Carton	毛重 GW/CTN	单支重 NW/PC
M 64535	115mm	6pcs	120pcs	15.5kg	0.1kg

- CRV 刀片, 优质红木手柄, 锋利耐用
- △ 本品属于易耗品, 不属于终身保用范围
- CRV blade, sharp and durable, with wood handle
- △ No warranty as consumables

铝合金手电筒
Aluminium Alloy Flashlight



货号 Item No	规格 Size	装盒数 Pc/Box	装箱数 Pc/ Carton	毛重 GW/CTN	单支重 NW/PC
M 64737	3V/1LED	6pcs	60pcs	5.70kg	0.070kg

- △ 本品属于易耗品, 不属于终身保用范围
- △ No warranty as consumables

锂电手持LED灯 (18珠)
18-LED Li-Ion Portable Worklight



货号 Item No	规格 Size	装盒数 Pc/ Carton	毛重 GW/CTN	单支重 NW/PC
M 64720	18珠	10pcs	3.00kg	0.20kg

- △ 超大容量锂电池
- △ 8小时超长点亮时间
- △ 18珠超亮LED灯泡
- △ 本品属于易耗品, 不属于终身保用范围
- △ No warranty as consumables

外热式电烙铁
Soldering Iron



货号 Item No	规格 Size	装盒数 Pc/Box	装箱数 Pc/ Carton	毛重 GW/CTN	单支重 NW/PC
M 64441	30W	6pcs	60pcs	10.7kg	0.138kg
M 64442	40W	6pcs	60pcs	11.2kg	0.138kg
M 64443	60W	6pcs	60pcs	11.7kg	0.148kg
M 64444	80W	6pcs	48pcs	15.3kg	0.292kg
M 64445	100W	6pcs	48pcs	16.7kg	0.293kg
M 64446	150W	6pcs	48pcs	17.6kg	0.333kg
M 64447	200W	6pcs	24pcs	13.68kg	0.494kg
M 64448	300W	6pcs	24pcs	17.5kg	0.65kg

- 紫铜芯子, 不锈钢护罩
- △ 本品属于易耗品, 不属于终身保用范围
- Purple copper core, stainless steel shuck
- △ No warranty as consumables

搭配使用零部件

针式电烙铁头
Tips

货号 Item No	规格 Size	装盒数 Pc/Box	单支重 NW/PC
M 99150	30W	10pcs	0.010kg
M 99151	40W	10pcs	0.010kg
M 99152	60W	10pcs	0.020kg

紫铜电烙铁弯头
Purple Copper Tips

货号 Item No	规格 Size	装盒数 Pc/Box	单支重 NW/PC
M 99163	80W	2pcs	0.030kg
M 99164	100W	2pcs	0.050kg
M 99165	150W	2pcs	0.060kg
M 99166	200W	2pcs	0.190kg
M 99167	300W	2pcs	0.320kg

电烙铁芯子
Mica Heater

货号 Item No	规格 Size	装盒数 Pc/Box	单支重 NW/PC
M 99178	30W	2pcs	0.01kg
M 99179	40W	2pcs	0.01kg
M 99180	60W	2pcs	0.01kg
M 99181	80W	2pcs	0.03kg
M 99182	100W	2pcs	0.03kg
M 99183	150W	2pcs	0.04kg
M 99184	200W	2pcs	0.07kg
M 99185	300W	2pcs	0.10kg

电工胶带
Electrical Tape



货号 Item No	规格 Size	装盒数 Pc/Box	装箱数 Pc/ Carton	毛重 GW/CTN	单支重 NW/PC
M 64556	18mm × 0.18mm × 11m	10pcs	300pcs	17.5kg	0.057kg

- △ 本品属于易耗品, 不属于终身保用范围
- △ No warranty as consumables

15件VDE绝缘维修组套
15pcs Insulated Maintenance Set



货号 Item No	规格 Size	装箱数 Set /Carton	毛重 GW/CTN	每套重量 Weight Per Set
M07315	15pcs	3sets	10.50kg	3.17kg

- 绝缘耐压钢丝钳 200mm
- 绝缘耐压尖嘴钳 200mm
- 绝缘耐压斜嘴钳 160mm
- 绝缘耐压剥线钳 160mm
- 绝缘电工刀 50x180mm
- 绝缘十字螺丝批 PH0x75,PH1x100,PH2x100,PH3x150
- 绝缘一字螺丝批 0.4x2.5x80,0.5x3x100,0.8x4x100,1x5.5x125,1.2x6.5x150
- 测电笔 3x70mm
- 1pc Insulated Combination Pliers 200mm
- 1pc Insulated Long Nose Pliers 200mm
- 1pc Insulated Diagonal Pliers 160mm
- 1pc Insulated Wire Stripping Pliers 160mm
- 1pc Insulated Cable Knife 50x180mm
- 4pcs Insulated Screwdriver Phillips PH0x75,PH1x100,PH2x100,PH3x150
- 5pcs Insulated Screwdriver Slotted 0.4x2.5x80,0.5x3x100,0.8x4x100,1x5.5x125,1.2x6.5x150
- 1pc Voltage Tester 3x70mm

△ 本品属于易耗品, 不属于终身保用范围
△ No warranty as consumables

18件VDE绝缘维修组套
18pcs Insulated Maintenance Set



货号 Item No	规格 Size	装箱数 Set /Carton	毛重 GW/CTN	每套重量 Weight Per Set
M07317	18pcs	3sets	12.50kg	3.67kg

- 绝缘耐压钢丝钳 200mm
- 绝缘耐压尖嘴钳 160mm
- 绝缘耐压斜嘴钳 160mm
- 绝缘耐压剥线钳 160mm
- 绝缘耐压活扳手 250mm
- 绝缘电工刀(镰刀型) 50x180mm
- 绝缘耐压呆扳手 10,12,14,17,19mm
- 绝缘十字螺丝批 PH0x75,PH1x100,PH2x100
- 绝缘一字螺丝批 0.4x3x100,0.8x4x100,1x5.5x125
- 测电笔 3x70mm
- 1pc Insulated Combination Pliers 200mm
- 1pc Insulated Long Nose Pliers 200mm
- 1pc Insulated Diagonal Pliers 160mm
- 1pc Insulated Wire Stripping Pliers 160mm
- 1pc Insulated Adjustable Wrench 250mm
- 1pc Insulated Cable Knife 50x180mm
- 5pcs Insulated Opening Wrench 10,12,14,17,19mm
- 3pcs Insulated Screwdriver Phillips PH0x75,PH1x100,PH2x100
- 3pcs Insulated Screwdriver Slotted 0.4x3x100,0.8x4x100,1x5.5x125
- 1pc Voltage Tester 3x70mm

△ 本品属于易耗品, 不属于终身保用范围
△ No warranty as consumables

19件VDE绝缘维修组套
19pcs Insulated Maintenance Set



货号 Item No	规格 Size	装箱数 Set /Carton	毛重 GW/CTN	每套重量 Weight Per Set
M 07318	19pcs	3sets	15.60kg	3.75kg

- 绝缘耐压钢丝钳 160mm
- 绝缘耐压尖嘴钳 160mm
- 绝缘耐压斜嘴钳 160mm
- 绝缘耐压剥线钳 160mm
- 绝缘耐压活扳手 200mm
- 绝缘电工刀(镰刀型) 50x180mm
- 绝缘胶带 0.18mmx18mmx11M
- 绝缘耐压呆扳手 10,14,17mm
- 绝缘耐压梅花扳手 10,14,19mm
- 绝缘十字螺丝批 PH0x3x75, PH1x5x100
- 绝缘一字螺丝批 3x100, 5.5x125, 4x100mm
- 测电笔 3X70mm
- 1pc Insulated Combination Pliers 160mm
- 1pc Insulated Long Nose Pliers 160mm
- 1pc Insulated Diagonal Pliers 160mm
- 1pc Insulated Wire Stripping Pliers 160mm
- 1pc Insulated Adjustable Wrench 200mm
- 1pc Insulated Cable Knife 50x180mm
- 1pc Electrical Tape 0.8x18x11mm
- 3pcs Insulated Opening Wrench 10,14,17mm
- 3pcs Insulated Ring Wrench 10,14,19mm
- 2pcs Insulated Screwdriver Phillips PH0x3x75,PH1x5x100
- 3pcs Insulated Screwdriver Slotted 3x100,5.5x125,4x100
- 1pc Voltage Tester 3x70mm

△ 本品属于易耗品, 不属于终身保用范围
△ No warranty as consumables

25件VDE绝缘维修组套
25pcs Insulated Maintenance Set



货号 Item No	规格 Size	装箱数 Set /Carton	毛重 GW/CTN	每套重量 Weight Per Set
M 07325	25pcs	3sets	17.10kg	5.37kg

- 绝缘耐压钢丝钳 175mm
- 绝缘耐压尖嘴钳 160mm
- 绝缘耐压斜嘴钳 160mm
- 绝缘耐压活扳手 200mm
- 绝缘耐压棘轮扳手 12.5mm
- 1/2" 系列六角绝缘套筒 10, 11, 12, 13, 14, 16, 17, 18, 19, 22, 24, 27, 30, 32mm
- 绝缘十字螺丝批 PH1x100, PH2x100
- 绝缘一字螺丝批 0.8x4x100, 1x5.5x125
- 1/2" 系列绝缘接杆 125, 250mm
- 1pc Insulated Combination Pliers 175mm
- 1pc Insulated Long Nose Pliers 160mm
- 1pc Insulated Diagonal Pliers 160mm
- 1pc Insulated Adjustable Wrench 200mm
- 1pc 1/2" Dr. Insulated Ratchet
- 14pcs 1/2" Dr. Insulated Socket 10,11,12,13,14,16,17,18,19,22,24,27,30,32mm
- 2pcs Insulated Screwdriver Phillips PH1x100,PH2x100
- 2pcs Insulated Screwdriver Slotted 0.8x4x100,1x5.5x125
- 2pcs Insulated Extension Bar 125,250mm

△ 本品属于易耗品, 不属于终身保用范围
△ No warranty as consumables



VDE绝缘钢丝钳

VDE Insulated Combination Pliers



CR-V



1000V
IEC 60900

符合BS EN 60900-2004标准

货号 Item No	规格 Size	总长L length	H	C	装盒数 Pc/Box	装箱数 Pc/ Carton	毛重 GW/CTN	单支重 NW/PC
M 28527	160mm(6")	163mm	35mm	35mm	6pcs	48pcs	13.60kg	0.260kg
M 28528	175mm(7")	188mm	38mm	36mm	6pcs	48pcs	17.00kg	0.313kg
M 28529	200mm(8")	195mm	41mm	36mm	6pcs	48pcs	27.00kg	0.521kg

·通过VDE认证,每支产品经过绝缘耐压10000V测试,符合IEC/EN 60900标准
·铬钒钢整体锻造,镀铬表面处理,刃口硬度高,使用寿命长
·刃口经过高频硬化处理,硬度达到HRC60 ·产品采用偏心省力设计
△本品属易耗品,不属于终身保用范围
·VDE certified. Each product has passed 10,000V insulation test, comply with IEC/EN 60900 standards.
·Made of drop-forged Cr-V steel, nickel-plated surface. High cutting hardness, long service life.
·The cutting edge is treated by induction heat treatment, hardness HRC60.
·Eccentric and labor-saving design.
△ No warranty as consumables

VDE绝缘斜嘴钳

VDE Insulated Diagonal Pliers



CR-V



1000V
IEC 60900

符合BS EN 60900-2004标准

货号 Item No	规格 Size	总长L length	H	C	装盒数 Pc/Box	装箱数 Pc/ Carton	毛重 GW/CTN	单支重 NW/PC
M 28543	160mm(6")	160mm	19.32mm	19mm	6pcs	48pcs	14.40kg	0.281kg
M 28544	200mm(8")	205mm	26.15mm	17mm	6pcs	48pcs	22.00kg	0.417kg

·通过VDE认证,每支产品经过绝缘耐压10000V测试,符合IEC/EN 60900标准
·铬钒钢整体锻造,镀铬表面处理,刃口硬度高,使用寿命长
·刃口经过高频硬化处理,硬度达到HRC60 ·产品采用偏心省力设计
△本品属易耗品,不属于终身保用范围
·VDE certified. Each product has passed 10,000V insulation test, comply with IEC/EN 60900 standards.
·Made of drop-forged Cr-V steel, nickel-plated surface. High cutting hardness, long service life.
·The cutting edge is treated by induction heat treatment, hardness HRC60.
·Eccentric and labor-saving design.
△ No warranty as consumables

VDE绝缘尖嘴钳

VDE Insulated Long Nose Pliers

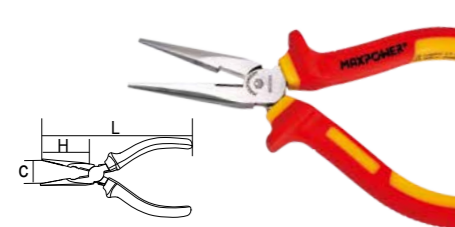

CR-V



1000V
IEC 60900

符合BS EN 60900-2004标准

货号 Item No	规格 Size	总长L length	H	C	装盒数 Pc/Box	装箱数 Pc/ Carton	毛重 GW/CTN	单支重 NW/PC
M 28563	160mm(6")	160mm	50mm	65mm	6pcs	48pcs	9.50kg	0.177kg
M 28564	200mm(8")	200mm	75mm	90mm	6pcs	48pcs	13.90kg	0.260kg

·通过VDE认证,每支产品经过绝缘耐压10000V测试,符合IEC/EN 60900标准
·铬钒钢整体锻造,镀铬表面处理,刃口硬度高,使用寿命长
·刃口经过高频硬化处理,硬度达到HRC60 ·产品采用偏心省力设计
△本品属易耗品,不属于终身保用范围
·VDE certified. Each product has passed 10,000V insulation test, comply with IEC/EN 60900 standards.
·Made of drop-forged Cr-V steel, nickel-plated surface. High cutting hardness, long service life.
·The cutting edge is treated by induction heat treatment, hardness HRC60.
·Eccentric and labor-saving design.
△ No warranty as consumables

VDE绝缘剥线钳

VDE Insulated Wire Stripping Pliers



CR-V



1000V
IEC 60900

符合BS EN 60900-2004标准

货号 Item No	规格 Size	装盒数 Pc/Box	装箱数 Pc/ Carton	毛重 GW/CTN	单支重 NW/PC
M 28578	160mm(6")	6pcs	48pcs	12.90kg	0.240kg

·通过VDE认证,每支产品经过绝缘耐压10000V测试,符合IEC/EN 60900标准·铬钒钢整体锻造,镀铬表面处理,刃口硬度高,使用寿命长·硬度达到HRC40 ·产品采用偏心省力设计
△本品属易耗品,不属于终身保用范围
·VDE certified. Each product has passed 10,000V insulation test, comply with IEC/EN 60900 standards.
·Made of drop-forged Cr-V steel, nickel-plated surface. High cutting hardness, long service life.
·hardness HRC40. ·Eccentric and labor-saving design.
△ No warranty as consumables

绝缘注塑开口扳手

VDE Insulated Open Wrench



NEW



1000V
IEC 60900

货号 Item No	规格 Size	总长 length	B	D	装盒数 Pc/Box	装箱数 Pc/ Carton	毛重 GW/CTN	单支重 NW/PC
M71608	8mm	100mm	27mm	7.9mm	20pcs	240pcs	8.20kg	0.03kg
M71610	10mm	110mm	28mm	8.4mm	20pcs	240pcs	10.60kg	0.04kg
M71612	12mm	130mm	33mm	8.8mm	20pcs	120pcs	8.20kg	0.06kg
M71613	13mm	136mm	33.5mm	9.5mm	20pcs	120pcs	8.80kg	0.065kg
M71614	14mm	147mm	37mm	9.7mm	6pcs	96pcs	9.16kg	0.085kg
M71617	17mm	152mm	43.8mm	10.5mm	6pcs	60pcs	7.60kg	0.11kg
M71619	19mm	176mm	47mm	11mm	6pcs	60pcs	10.00kg	0.15kg
M71622	22mm	194mm	53.5mm	12.7mm	6pcs	48pcs	11.80kg	0.225kg
M71624	24mm	228mm	56mm	13mm	6pcs	48pcs	14.20kg	0.275kg
M71627	27mm	253mm	61.5mm	13.8mm	6pcs	24pcs	9.76kg	0.365kg
M71630	30mm	293mm	66mm	14.8mm	6pcs	24pcs	13.12kg	0.505kg
M71632	32mm	312mm	70mm	15.5mm	6pcs	24pcs	15.52kg	0.605kg

·通过VDE认证,每支产品经过绝缘耐压10000V测试,符合IEC/EN 60900标准
·金属部分Cr-V材料锻压成型,表面镀铬处理,美观防锈
△本品属易耗品,不属于终身保用范围
·VDE certified. Each product has passed 10,000V insulation test, comply with IEC/EN 60900 standards.
·Made of drop-forged Cr-V steel, with chrome plated surface, beautiful and rust-proof
△ No warranty as consumables

绝缘注塑梅花扳手

VDE Insulated Box Wrench



NEW



1000V
IEC 60900

货号 Item No	规格 Size	总长 length	B	D	装盒数 Pc/Box	装箱数 Pc/ Carton	毛重 GW/CTN	单支重 NW/PC
M71508	8mm	160mm	18mm	8mm	6pcs	240pcs	17.80kg	0.07kg
M71510	10mm	175mm	21mm	10mm	12pcs	240pcs	25.00kg	0.1kg
M71512	12mm	200mm	24mm	10mm	12pcs	120pcs	17.20kg	0.135kg
M71513	13mm	200mm	27mm	11mm	12pcs	120pcs	17.80kg	0.14kg
M71514	14mm	210mm	27mm	11mm	12pcs	96pcs	16.36kg	0.16kg
M71517	17mm	220mm	30mm	13mm	6pcs	60pcs	13.00kg	0.2kg
M71519	19mm	235mm	34mm	15mm	6pcs	60pcs	15.40kg	0.24kg
M71522	22mm	255mm	38mm	15mm	6pcs	48pcs	16.12kg	0.315kg
M71524	24mm	275mm	42mm	17mm	6pcs	48pcs	18.52kg	0.365kg
M71527	27mm	300mm	45mm	17mm	6pcs	24pcs	10.96kg	0.415kg
M71530	30mm	325mm	49mm	18mm	6pcs	24pcs	13.84kg	0.535kg
M71532	32mm	330mm	51mm	18mm	6pcs	24pcs	14.32kg	0.555kg

·通过VDE认证,每支产品经过绝缘耐压10000V测试,符合IEC/EN 60900标准
·金属部分Cr-V材料锻压成型,表面镀铬处理,美观防锈
△本品属易耗品,不属于终身保用范围
·VDE certified. Each product has passed 10,000V insulation test, comply with IEC/EN 60900 standards.
·Made of drop-forged Cr-V steel, with chrome plated surface, beautiful and rust-proof
△ No warranty as consumables

绝缘注塑棘轮扳手

VDE Insulated Ratchet



NEW



1000V
IEC 60900

货号 Item No	规格 Size	装盒数 Pc/Box	装箱数 Pc/ Carton	毛重 GW/CTN	单支重 NW/PC
M 48344	10mm	3pcs	48pcs	18.76kg	0.37kg
M 48345	12.5mm	3pcs	36pcs	15.76kg	0.41kg

·通过VDE认证,每支产品经过绝缘耐压10000V测试,符合IEC/EN 60900标准
·VDE certified. Each product has passed 10,000V insulation test, comply with IEC/EN 60900 standards.

VDE绝缘接杆

Insulated Extension Bar



NEW



1000V
IEC 60900

10mm系列 3/8"Dr.

货号 Item No	规格 Size	装盒数 Box	装箱数 Carton	毛重 GW/CTN	单支重 NW/PC
M71206	125mm	6pcs	48 pcs	7.42kg	0.140kg

12.5mm系列 1/2"Dr.

货号 Item No	规格 Size	装盒数 Box	装箱数 Carton	毛重 GW/CTN	单支重 NW/PC
M71212	125mm	6pcs	48 pcs	11.36kg	0.222kg
M71213	250mm	6pcs	48 pcs	21.56kg	0.435kg

·通过VDE认证,每支产品经过绝缘耐压10000V测试,符合IEC/EN 60900标准
·VDE certified. Each product has passed 10,000V insulation test, comply with IEC/EN 60900 standards.

绝缘耐高压活扳手

VDE Insulated Adjustable Wrench



CR-V



1000V
IEC 60900

货号 Item No	规格 Size	L(总长) length	开口量 Opening Capacity	装盒数 Pc/Box	装箱数 Pc/ Carton	毛重 GW/CTN	单支重 NW/PC
M11523	200mm(8")	200mm	30mm	4pcs	60pcs	17.80kg	0.262kg
M11524	250mm(10")	250mm	35mm	4pcs	48pcs	21.70kg	0.420kg
M11525	300mm(12")	300mm	41mm	4pcs	36pcs	18.50kg	0.685kg

·通过VDE认证,每支产品经过绝缘耐压10000V测试,符合IEC/EN 60900标准 ·耐高压、耐腐蚀
·铬钒钢整体锻造,使用寿命长 ·镀铬表面处理,耐腐蚀
△本品属易耗品,不属于终身保用范围
·VDE certified. Each product has passed 10,000V insulation test, comply with IEC/EN 60900 standards.
·High voltage resistance, corrosion resistance. ·Made of drop-forged Cr-V steel, long service life.
△ No warranty as consumables

VDE绝缘套筒

VDE Insulated Socket



1000V
IEC 60900

10mm系列六角套筒
(3/8"Dr.6pt Socket)

货号 Item No	规格 Size	装盒数 Pc/Box	装箱数 Pc/ Carton	毛重 GW/CTN	单支重 NW/PC
M 71038	8mm	20pcs	240pcs	7kg	0.025kg
M 71039	9mm	20pcs	240pcs	7.4kg	0.027kg
M 71040	10mm	20pcs	240pcs	7.6kg	0.028kg
M 71041	11mm	20pcs	240pcs	7.9kg	0.029kg
M 71042	12mm	20pcs	240pcs	8.4kg	0.031kg
M 71043	13mm	20pcs	240pcs	9.2kg	0.035kg
M 71044	14mm	20pcs	240pcs	8.9kg	0.033kg
M 71045	15mm	20pcs	240pcs	10.5kg	0.040kg
M 71046	16mm	20pcs	240pcs	10.5kg	0.040kg
M 71047	17mm	20pcs	120pcs	6.1kg	0.044kg
M 71048	18mm	20pcs	120pcs	6.9kg	0.051kg
M 71049	19mm	20pcs	120pcs	6.8kg	0.050kg
M 71050	20mm	20pcs	120pcs	7.8kg	0.058kg
M 71051	21mm	20pcs	120pcs	7.3kg	0.054kg
M 71052	22mm	12pcs	96pcs	6.6kg	0.060kg

12.5mm系列六角套筒
(1/2"Dr.6pt Socket)

货号 Item No	规格 Size	装盒数 Pc/Box	装箱数 Pc/ Carton	毛重 GW/CTN	单支重 NW/PC
M 71068	8mm	20pcs	240pcs	13.6kg	0.053kg
M 71069	9mm	20pcs	240pcs	14.1kg	0.055kg
M 71070	10mm	20pcs	240pcs	13.8kg	0.054kg
M 71071	11mm	20pcs	240pcs	14.6kg	0.058kg
M 71072	12mm	20pcs	240pcs	15.1kg	0.060kg
M 71073	13mm	20pcs	240pcs	15.7kg	0.063kg
M 71074	14mm	20pcs	240pcs	16kg	0.064kg
M 71075	15mm	20pcs	120pcs	8.5kg	0.066kg
M 71076	16mm	20pcs	120pcs	8.3kg	0.064kg
M 71077	17mm	20pcs	120pcs	9.1kg	0.071kg
M 71078	18mm	20pcs	120pcs	10.2kg	0.080kg
M 71079	19mm	20pcs	120pcs	8.7kg	0.067kg
M 71080	20mm	20pcs	120pcs	10kg	0.078kg
M 71081	21mm	20pcs	120pcs	9.1kg	0.071kg

深孔三色VDE绝缘螺丝批

VDE Insulated Screwdriver



深孔三色VDE绝缘一字螺丝批

VDE Insulated Screwdriver Slotted

货号 Item No	规格 Size	装盒数 Pc/Box	装箱数 Pc/Carton	毛重 GW/CTN	单支重 NW/PC
M 55630	4x100mm	8 pcs	96 pcs	5.12kg	0.043kg
M 55631	5.5x125mm	8 pcs	96 pcs	6.57kg	0.058kg
M 55632	6.5x150mm	8 pcs	96 pcs	10.02kg	0.094kg

深孔三色VDE绝缘十字螺丝批

VDE Insulated Screwdriver Phillips

货号 Item No	规格 Size	装盒数 Pc/Box	装箱数 Pc/Carton	毛重 GW/CTN	单支重 NW/PC
M 55643	PH1x100mm	8 pcs	96 pcs	5.80 kg	0.050kg
M 55644	PH2x100mm	8 pcs	96 pcs	8.39 kg	0.077kg

- 刀杆采用优质 Cr-Mo 加工而成，整体热处理
- 手柄用绝缘材料注塑而成，手感舒适
- 通过 VDE 认证，每支产品都通过耐高压测试
- Made of Cr-Mo, heat treatment
- Handle injected with insulation material, comfortable
- With VDE approval, each has passed high voltage test



薄型批覆 可操作深孔内螺丝



VDE绝缘螺丝批

VDE Insulated Screwdriver



VDE绝缘一字螺丝批

VDE Insulated Screwdriver Slotted

货号 Item No	规格 Size	装盒数 Pc/Box	装箱数 Pc/Carton	毛重 GW/CTN	单支重 NW/PC
M 55622	3 x 100mm	12pcs	144pcs	4.2kg	0.024kg
M 55623	4 x 100mm	12pcs	144pcs	7.3kg	0.043kg
M 55624	5.5 x 125mm	12pcs	144pcs	9.6kg	0.059kg
M 55625	6.5 x 150mm	12pcs	144pcs	15.6kg	0.096kg
M 55626	8.0 x 175mm	6pcs	72pcs	11.66kg	0.142kg

VDE绝缘十字螺丝批

VDE Insulated Screwdriver Phillips

货号 Item No	规格 Size	装盒数 Pc/Box	装箱数 Pc/Carton	毛重 GW/CTN	单支重 NW/PC
M 55636	PH0 x 75mm	12pcs	144pcs	4.00kg	0.022kg
M 55637	PH1 x 100mm	12pcs	144pcs	8.3kg	0.049kg
M 55638	PH2 x 100mm	12pcs	144pcs	12.8kg	0.82kg
M 55639	PH3 x 150mm	6pcs	72pcs	11.2kg	0.144kg

- 刀杆采用优质 Cr-Mo 加工而成，整体热处理
- 手柄用绝缘材料注塑而成，手感舒适
- 通过 VDE 认证，每支产品都通过耐高压测试
- Made of Cr-Mo, heat treatment
- Handle injected with insulation material, comfortable
- With VDE approval, each has passed high voltage test

绝缘螺丝批

Insulated Screwdriver



一字绝缘螺丝批

Insulated Screwdriver Slotted

货号 Item No	规格 Size	装盒数 Pc/Box	装箱数 Pc/Carton	毛重 GW/CTN	单支重 NW/PC
07041303	3 x 75mm	12pcs	120pcs	4.30kg	0.032kg
07041404	4 x 100mm	12pcs	120pcs	8.50kg	0.067kg
07041505	5.5 x 125mm	12pcs	120pcs	12.60kg	0.096kg
07041606	6.5 x 150mm	12pcs	120pcs	14.00kg	0.108kg

※本款产品即将退市, 库存售完为止

十字绝缘螺丝批

Insulated Screwdriver Phillips

货号 Item No	规格 Size	装盒数 Pc/Box	装箱数 Pc/Carton	毛重 GW/CTN	单支重 NW/PC
07042303	PH0 x 75 mm	12pcs	120pcs	4.18kg	0.029kg
07042403	PH1 x 75 mm	12pcs	120pcs	8.30kg	0.063kg

※本款产品即将退市, 库存售完为止

- 刀杆采用优质 CrMoV 加工而成，整体热处理
- 手柄用绝缘材料注塑而成，手感舒适
- 通过 VDE 认证，每支产品都通过耐高压测试
- 本品属于易耗品, 不属于终身保用范围
- Made of CrMoV, heat treatment
- Handle injected with insulation material, comfortable
- With VDE approval, each has passed high voltage test
- No warranty as consumables

VDE绝缘电缆刀

VDE Insulated Cable Knife



VDE绝缘直平护套电缆刀

VDE Insulated Cable Knife - Flat Blade

货号 Item No	规格 Size	装盒数 Pc/Box	装箱数 Pc/Carton	毛重 GW/CTN	单支重 NW/PC
M 71820	50x180mm	12pcs	96pcs	9.06kg	0.084kg

- 通过VDE认证, 每支产品经过绝缘耐压10000V测试, 符合IEC/EN 60900标准
- 本品属易耗品, 不属于终身保用范围
- VDE certified. Each product has passed 10,000V insulation test, comply with IEC/EN 60900
- No warranty as consumables



VDE绝缘圆型电缆刀

VDE Insulated Cable Knife - Round Blade

货号 Item No	规格 Size	装盒数 Pc/Box	装箱数 Pc/Carton	毛重 GW/CTN	单支重 NW/PC
M 71815	28x155mm	12pcs	96pcs	8.30kg	0.076kg

- 通过VDE认证, 每支产品经过绝缘耐压10000V测试, 符合IEC/EN 60900标准
- 本品属易耗品, 不属于终身保用范围
- VDE certified. Each product has passed 10,000V insulation test, comply with IEC/EN 60900
- No warranty as consumables



VDE绝缘镰刀型电缆刀

VDE Insulated Cable Knife - Sickle Blade

货号 Item No	规格 Size	装盒数 Pc/Box	装箱数 Pc/Carton	毛重 GW/CTN	单支重 NW/PC
M 71810	50x180mm	12pcs	96pcs	8.50kg	0.078kg

- 通过VDE认证, 每支产品经过绝缘耐压10000V测试, 符合IEC/EN 60900标准
- 本品属易耗品, 不属于终身保用范围
- VDE certified. Each product has passed 10,000V insulation test, comply with IEC/EN 60900
- No warranty as consumables

VDE双色绝缘电缆剪

VDE Insulated Cable Cutter



A款

应用范围: 剪切铜线及铝线

货号 Item No	规格 Size	mm (MAX)	mm ² (MAX)	装盒数 Pc/Box	装箱数 Pc/Carton	毛重 GW/CTN	单支重 NW/PC
M 33888	150mm	5.2mm	22mm ²	6pcs	48pcs	13.48kg	0.26kg



B款

货号 Item No	规格 Size	mm (MAX)	mm ² (MAX)	装盒数 Pc/Box	装箱数 Pc/Carton	毛重 GW/CTN	单支重 NW/PC
M 33890	250mm	10.0mm	80mm ²	6pcs	36pcs	22.96kg	0.61kg

· 通过德国VDE IEC/EN 60900高绝缘认证和GS品质认证 · 产品符合REACH(SVHC)环保标准

· 人体工学双色手柄, 胶柄采用耐高压、耐冻、阻燃材质制造

· 本体采用铬合金钢打造, 刀口经特殊硬化处理, 可剪切铜线及铝线 · 表面染黑防锈处理

Approved by Germany VDE IEC/EN 60900 high insulation certification and GS quality certification

Product meets REACH (SVHC) environmental protection standard

Ergonomic bi-color handle, made from high voltage resistant, cold-resistant and flame-resistant material

Body made of Cr-Mo alloy steel. The knife edge is specially hardened to cut copper wire and aluminum wire.

The incision is smooth and free of burrs. · Black rust resistant surface treatment.

VDE绝缘棘轮式电缆剪
VDE Insulated Cable Cutter



货号 Item No	规格 Size	mm (MAX)	装盒数 Pc/Box	装箱数 Pc/Carton	毛重 GW/CTN	单支重 NW/PC
M 71830	240mm	32mm	1pc	12pcs	8.74kg	0.72kg
M 71831	380mm	52mm	1pc	12pcs	12.46kg	1.11kg

·通过VDE认证,每支产品经过绝缘耐压10000V测试,符合IEC/EN 60900标准
产品符合REACH(SVHC)环保标准

人体工学双色手柄,胶柄采用耐高压、耐冻、耐燃材质制造
本体采用65Mn合金钢打造,刀口经特殊硬化处理,可剪切铜线及铝线,
切口平整无毛边

棘轮省力及安全释放按钮设计,操作轻松安全

VDE certified. Each product has passed 10,000V insulation test, comply with IEC/EN 60900
Product meets REACH (SVHC) environmental protection standard
Ergonomic bi-color handle, made from high voltage resistant, cold-resistant and flame-resistant material
Body made of 65Mn alloy steel. The knife edge is specially hardened to cut copper wire and aluminum wire. The incision is smooth and free of burrs.
Labor saving ratchet and safety release button design for easy and safe operation

VDE绝缘水泵钳
VDE Insulated Groove Joint Pliers



货号 Item No	规格 Size	夹持直径 (MAX) Clamping Dia (MAX)	装盒数 Pc/Box	装箱数 Pc/Carton	毛重 GW/CTN	单支重 NW/PC
M 29610	250mm	28mm	6pcs	36pcs	17.20kg	0.45kg
M 29611	300mm	35mm	4pcs	24pcs	17.08kg	0.67kg

·每支产品经过绝缘耐压10000V测试
·Cr-V材料锻压成型,强度更高
·表面镀铬处理,美观防锈
·本品属易耗品,不属于终身保用范围
·VDE certified. Each product has passed 10,000V insulation test, comply with IEC/EN 60900
·No warranty as consumables

浸塑型VDE绝缘套筒
VDE Insulated Socket



10mm系列六角套筒
(3/8"Dr.6pt Socket)

货号 Item No	规格 Size	装盒数 Pc/Box	装箱数 Pc/Carton	毛重 GW/CTN	单支重 NW/PC
M 72008	8mm	6 pcs	72pcs	3.15kg	0.034kg
M 72010	10mm	6 pcs	72pcs	4.08kg	0.047kg
M 72011	11mm	6 pcs	72pcs	4.08kg	0.047kg
M 72012	12mm	6 pcs	72pcs	4.08kg	0.047kg
M 72013	13mm	6 pcs	72pcs	4.08kg	0.047kg
M 72014	14mm	6 pcs	72pcs	4.08kg	0.047kg
M 72016	16mm	6 pcs	60pcs	4.00kg	0.055kg
M 72017	17mm	6 pcs	60pcs	4.30kg	0.060kg
M 72018	18mm	6 pcs	60pcs	4.30kg	0.060kg
M 72019	19mm	6 pcs	60pcs	4.60kg	0.065kg
M 72021	21mm	6 pcs	60pcs	5.20kg	0.075kg
M 72022	22mm	6 pcs	60pcs	5.20kg	0.075kg

12.5mm系列六角套筒
(1/2"Dr.6pt Socket)

货号 Item No	规格 Size	装盒数 Pc/Box	装箱数 Pc/Carton	毛重 GW/CTN	单支重 NW/PC
M 72110	10mm	6 pcs	72pcs	6.10kg	0.075kg
M 72111	11mm	6 pcs	72pcs	6.10kg	0.075kg
M 72112	12mm	6 pcs	72pcs	6.10kg	0.075kg
M 72113	13mm	6 pcs	72pcs	6.24kg	0.077kg
M 72114	14mm	6 pcs	72pcs	6.24kg	0.077kg
M 72116	16mm	6 pcs	60pcs	6.10kg	0.090kg
M 72117	17mm	6 pcs	60pcs	6.10kg	0.090kg
M 72118	18mm	6 pcs	60pcs	6.10kg	0.090kg
M 72119	19mm	6 pcs	60pcs	7.00kg	0.105kg
M 72121	21mm	6 pcs	48pcs	6.22kg	0.115kg
M 72122	22mm	6 pcs	48pcs	6.46kg	0.120kg
M 72124	24mm	6 pcs	48pcs	8.14kg	0.155kg
M 72127	27mm	6 pcs	48pcs	10.30kg	0.200kg
M 72130	30mm	6 pcs	48pcs	11.98kg	0.235kg
M 72132	32mm	6 pcs	48pcs	13.90kg	0.275kg

·通过VDE认证,每支产品经过绝缘耐压10000V测试,
符合IEC/EN 60900标准
·VDE certified. Each product has passed 10,000V insulation test,
comply with IEC/EN 60900

VDE绝缘开口扳手
VDE Insulated Open Wrench

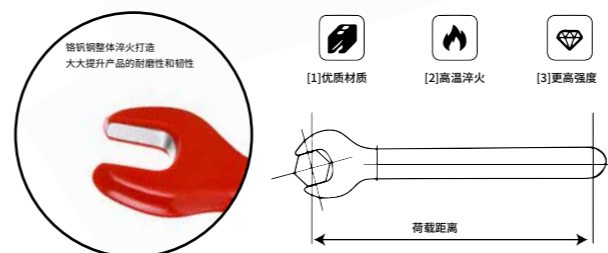

货号 Item No	规格 Size	装盒数 Pc/Box	装箱数 Pc/Carton	毛重 GW/CTN	单支重 NW/PC
M 72608	8mm	6 pcs	60pcs	3.40kg	0.04kg
M 72610	10mm	6 pcs	60pcs	4.00kg	0.05kg
M 72612	12mm	6 pcs	60pcs	4.90kg	0.07kg
M 72614	14mm	6 pcs	60pcs	6.40kg	0.09kg
M 72617	17mm	6 pcs	48pcs	5.80kg	0.10kg
M 72619	19mm	6 pcs	48pcs	6.76kg	0.12kg
M 72622	22mm	6 pcs	48pcs	8.68kg	0.16kg
M 72624	24mm	6 pcs	48pcs	9.64kg	0.18kg
M 72627	27mm	4 pcs	40pcs	11.80kg	0.27kg
M 72630	30mm	4 pcs	40pcs	13.00kg	0.30kg
M 72632	32mm	4 pcs	40pcs	16.20kg	0.38kg

·通过VDE认证,每支产品经过绝缘耐压10000V测试,
符合IEC/EN 60900标准
·VDE certified. Each product has passed 10,000V insulation test,
comply with IEC/EN 60900



VDE绝缘梅花扳手
VDE Insulated Ring Wrench



货号 Item No	规格 Size	装盒数 Pc/Box	装箱数 Pc/Carton	毛重 GW/CTN	单支重 NW/PC
M 72508	8mm	6 pcs	60pcs	3.40kg	0.040kg
M 72510	10mm	6 pcs	60pcs	4.00kg	0.050kg
M 72512	12mm	6 pcs	60pcs	4.90kg	0.065kg
M 72514	14mm	6 pcs	60pcs	6.10kg	0.085kg
M 72517	17mm	6 pcs	48pcs	5.56kg	0.095kg
M 72519	19mm	6 pcs	48pcs	5.80kg	0.100kg
M 72522	22mm	6 pcs	48pcs	8.68kg	0.160kg
M 72524	24mm	6 pcs	48pcs	11.08kg	0.210kg
M 72527	27mm	4 pcs	40pcs	11.20kg	0.255kg
M 72530	30mm	4 pcs	40pcs	15.20kg	0.355kg
M 72532	32mm	4 pcs	40pcs	17.20kg	0.405kg

·通过VDE认证,每支产品经过绝缘耐压10000V测试,符合IEC/EN 60900标准
·VDE certified. Each product has passed 10,000V insulation test, comply with IEC/EN 60900

VDE绝缘耐高压活扳手
VDE Insulated Adjustable Wrench



货号 Item No	规格 Size	L (总长) length	开口量 Opening Capacity	装盒数 Pc/Box	装箱数 Pc/Carton	毛重 GW/CTN	单支重 NW/PC
M 11515	150mm(6")	160mm	19mm	6pcs	48pcs	11.50kg	0.210kg
M 11516	200mm(8")	210mm	24mm	6pcs	48pcs	20.74kg	0.407kg
M 11517	250mm(10")	260mm	29mm	4pcs	36pcs	24.70kg	0.660kg
M 11518	300mm(12")	310mm	36mm	4pcs	24pcs	24.20kg	0.924kg

·通过VDE认证,每支产品经过绝缘耐压10000V测试,符合IEC/EN 60900标准
·整体优质合金钢锻造,坚固耐用
·精密螺母,开合自如 ·扳口上镭射刻度,便于操作
·VDE certified. Each product has passed 10,000V insulation test, comply with IEC/EN 60900
·Body drop forged with alloy steel
·Precision nut, open and close easily ·With laser metric or SAE scale

汽保类工具 / 拉马类工具 / 液压综合工具

Automotive Products / Puller Tools / Hydraulic Tools

润滑工具	133
扳手类维修工具	134-135
磁力盘	135
火花塞套筒	136
拉马	137-139
液压工具	140
千斤顶	140
日式手拉葫芦	141
Lubrication Tools	133
Wrench	134-135
Magnetic Disk	135
Spark Plug Socket	136
Puller	137-139
Hydraulic Tools	140
Jack	140
Japanese Type Chain Block	141

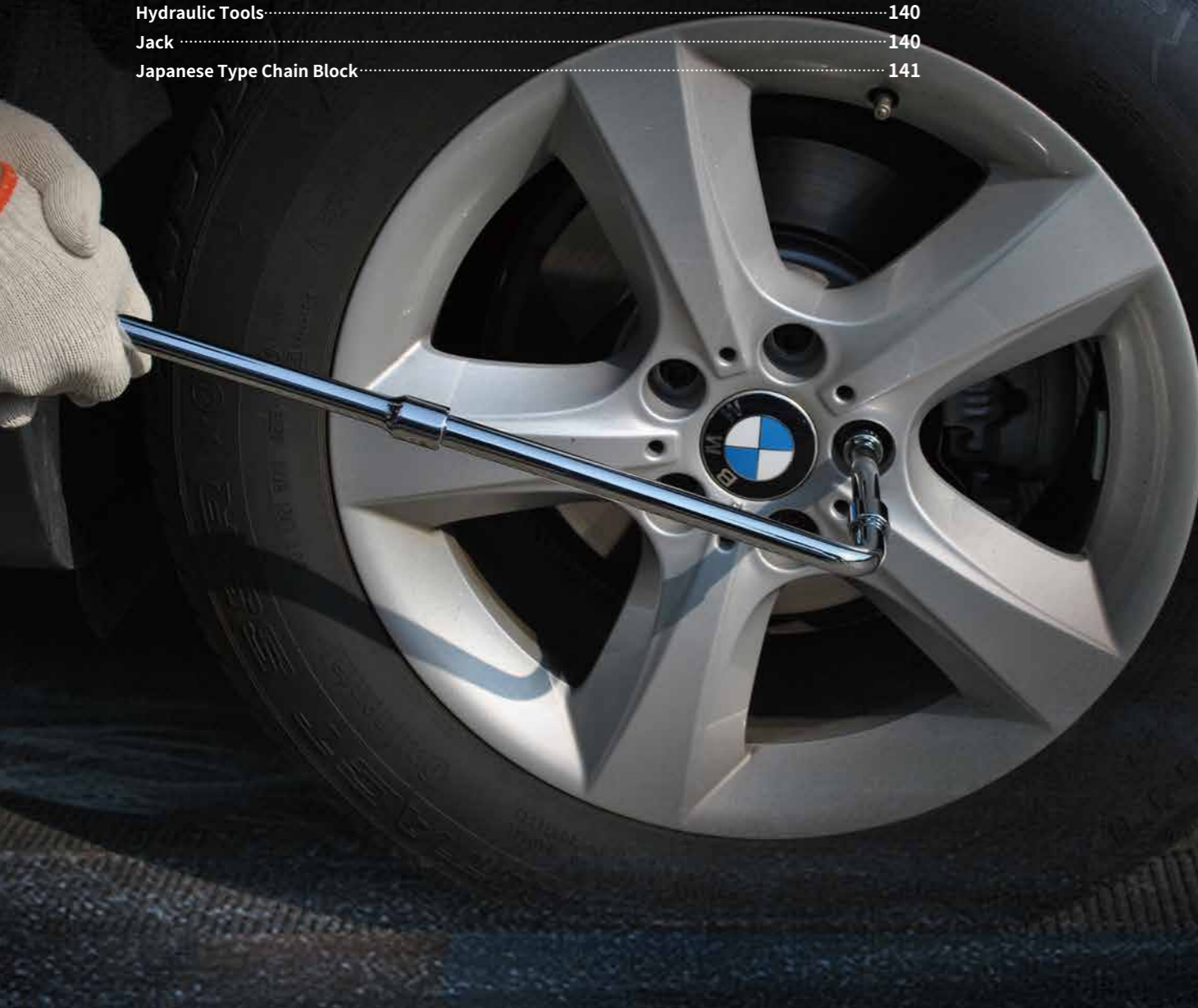

塑料机油枪 Plastic Pump Oiler



货号 Item No	规格 Size	装盒数 Pc/Box	装箱数 Pc/Carton	毛重 GW/CTN	单支重 NW/PC
M 40042	280ml	10pcs	120pcs	13.60kg	0.120kg

- 塑料枪体，不易碎，透明便于了解剩余油量
- Made of plastic, not easy to broken
- △ 本品属于易耗品，不属于终身保用范围
- △ No warranty as consumables

高压金属机油枪 Metal Pump Oiler



货号 Item No	规格 Size	装盒数 Pc/Box	装箱数 Pc/Carton	毛重 GW/CTN	单支重 NW/PC
M 40048	280ml	10pcs	80pcs	14.50kg	0.150kg

- 金属枪体，压力大，坚固耐用
- Made of metal valve, more durable in use
- △ 本品属于易耗品，不属于终身保用范围
- △ No warranty as consumables

高压黄油枪 High Pressure Grease Gun



货号 Item No	规格 Size	产品编号 Product No	装盒数 Pc/Box	装箱数 Pc/Carton	毛重 GW/CTN	单支重 NW/PC
M 40082	400cc	HY01	1pc	10pcs	16.30kg	1.38kg

- 使用无缝钢管制作而成，工作压力大，效率高
- 工作压力可达到 10000PSI
- Made of seamless steel pipe, high working pressure and efficiency
- 注：1 标准大气压 (atm)=14.696 磅 / 英寸² (psi)
- △ 本品属于易耗品，不属于终身保用范围
- △ No warranty as consumables

双杆黄油枪 Double Piston Grease Gun



货号 Item No	规格 Size	装盒数 Pc/Box	装箱数 Pc/Carton	毛重 GW/CTN	单支重 NW/PC
M 40083	600cc	1pc	10pcs	19.80kg	1.76kg

- 金属枪体，压力大，坚固耐用
- Made of metal valve, more durable in use
- △ 本品属于易耗品，不属于终身保用范围
- △ No warranty as consumables

重型黄油枪 Heavy Duty Grease Gun



货号 Item No	规格 Size	装盒数 Pc/Box	装箱数 Pc/Carton	毛重 GW/CTN	单支重 NW/PC
M 40084	800cc	1pc	8pcs	23.50kg	2.80kg

- 采用精密无缝钢管制造；精螺口设计，装卸方便，防沙损坏
- 手柄采用杠杆原理设计，轻松加油；螺口经过热处理经久耐用
- 工作压力可达到 18000PSI
- Made of precision seamless steel tubes, design with precision screw, easy to assemble and disassemble.
- handle designed with leverage, easy to add oil, heat treatment screw, durable

黄油枪搭配使用零部件

黄油枪软管 Grease Gun Hose

货号 Item No	规格 Size
M99430	30cm
M99431	40cm

黄油枪尖嘴 Grease Gun Pointy Nozzle

货号 Item No	规格 Size
M99428	400cc

黄油枪平嘴 Grease Gun Flat Nozzle

货号 Item No	规格 Size
M99429	400cc



INDEX

T型套筒扳手 镀铬
T-Type Wrench

CR-V

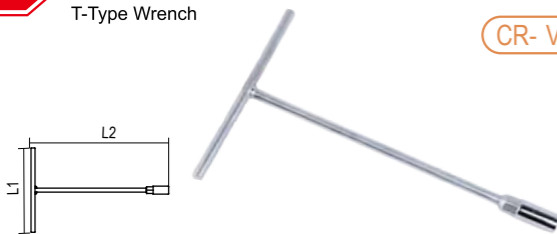

货号 Item No	规格 Size	L1	L2	装盒数 Pc/Box	装箱数 Pc/Carton	毛重 GW/CTN	单支重 NW/PC
M 40107	7mm	200mm	310mm	20pcs	80pcs	21.40kg	0.270kg
M 40108	8mm	200mm	310mm	20pcs	80pcs	25.80kg	0.270kg
M 40109	9mm	200mm	310mm	20pcs	80pcs	21.30kg	0.260kg
M 40110	10mm	200mm	310mm	20pcs	80pcs	26.20kg	0.280kg
M 40111	11mm	200mm	310mm	20pcs	80pcs	23.00kg	0.280kg
M 40112	12mm	200mm	310mm	20pcs	80pcs	28.40kg	0.290kg
M 40113	13mm	200mm	310mm	20pcs	80pcs	29.00kg	0.290kg
M 40114	14mm	200mm	310mm	20pcs	80pcs	29.30kg	0.340kg
M 40115	15mm	200mm	310mm	20pcs	80pcs	29.30kg	0.360kg
M 40116	16mm	200mm	310mm	20pcs	80pcs	30.50kg	0.360kg
M 40117	17mm	200mm	310mm	20pcs	60pcs	24.00kg	0.380kg
M 40118	18mm	200mm	310mm	20pcs	60pcs	25.70kg	0.420kg
M 40119	19mm	200mm	310mm	20pcs	60pcs	25.10kg	0.410kg

- 适合狭窄空间
- 套筒镜抛双色,手柄滚花,使用便捷、高效。
- Suit for using in narrow
- Mirror polished with chrome and satin finished ,easy to be use

三叉套筒扳手 镀铬
Y-Type Wrench

CR-V

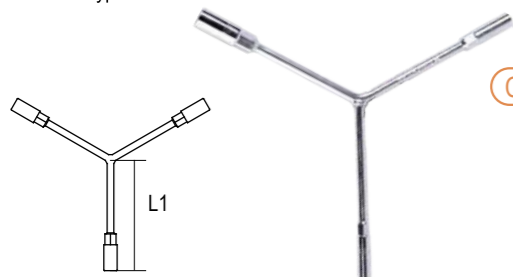

货号 Item No	规格 Size	L1	装盒数 Pc/Box	装箱数 Pc/Carton	毛重 GW/CTN	单支重 NW/PC
M 40168	8-9-10mm	150 mm	15pcs	60pcs	17.80kg	0.270kg
M 40169	8-10-12mm	150 mm	15pcs	60pcs	19.00kg	0.290kg
M 40170	10-11-13mm	150 mm	15pcs	60pcs	18.50kg	0.300kg
M 40171	10-12-14mm	150 mm	15pcs	60pcs	22.00kg	0.330kg
M 40172	12-13-14mm	150 mm	15pcs	60pcs	21.50kg	0.350kg
M 40173	12-14-17mm	150 mm	15pcs	60pcs	26.30kg	0.430kg
M 40174	14-17-19mm	150 mm	15pcs	60pcs	29.30kg	0.480kg

- 套筒镜抛双色,手柄滚花,使用便捷、高效。
- Mirror polished with chrome and satin finished ,easy to be use

快速十字扳手-自救之星
Rapid Cross Wrench

CR-V

防身/防水灾/防爆胎



适合放在主驾座位左侧

货号 Item No	规格 Size	装盒数 Pc/Box	装箱数 Pc/Carton	毛重 GW/CTN	单支重 NW/PC
M 40279	17-19-21-23mm	1pc	12pcs	23.2kg	1.53kg

- 携带方便,装卸轮胎更省时省力
- 自救之星,应急、防身必备随车工具
- Patent products ZL200920227325.8
- Easy to carry,save more power when loading and unloading tyres
- Self-rescue star, the necessity in the car for emergency and safety

十字轮胎扳手
Cross Rim Wrench

CR-V



货号 Item No	规格 Size	装盒数 Pc/Box	装箱数 Pc/Carton	毛重 GW/CTN	单支重 NW/PC
M 40251	350mm	2pcs	16pcs	23.50kg	1.330kg
M 40252	400mm	2pcs	16pcs	24.00kg	1.360kg
M 40253	450mm	2pcs	16pcs	28.00kg	1.520kg
M 40254	500mm	2pcs	12pcs	22.80kg	1.700kg

- 十字端套筒规格: 17,19,21,23mm
- 使用寿命长,强度超过标准 30% 以上
- 整体优质铬钒钢锻造,表面镀铬
- 加护套,使用安全,滚花美观防滑
- Sockets sizes: 17,19,21,23mm
- Drop forged with super CRV steel, chrome plated.
- Long using life, strength can exceed standard more than 30%
- With jacket on the cross,safe to be used,knurl handle avoid slipping

伸缩杆轮胎扳手 镀铬
Telescopic Lug Wrench

CR-V



货号 Item No	规格 Size	装盒数 Pc/Box	装箱数 Pc/Carton	毛重 GW/CTN	单支重 NW/PC
M 40212	17-23mm	4pcs	24pcs	28.60kg	1.170kg

- 可伸缩,方便携带
- 拉伸后长度 540mm
- Can stretch, easy to take
- The length can be 540mm

L型轮胎扳手
L Wrench

CR-V



★此产品售完为止

货号 Item No	M40224	M40225	M40226	M40227	M40228	M40229
规格 Size	17mm	19mm	21mm	22mm	23mm	24mm
装盒数 Pc/Box	6pcs	6pcs	6pcs	6pcs	6pcs	6pcs
装箱数 Pc/Carton	48pcs	48pcs	48pcs	48pcs	48pcs	48pcs
毛重 GW/CTN	27.50kg	27.20kg	28.50kg	30.30kg	30.70kg	29.30kg
单支重 NW/PC	0.560kg	0.50kg	0.570kg	0.620kg	0.630kg	0.600kg

- 铬钒钢精锻,整支热处理
- 寿命长,强度高,可做撬杠用
- Drop forged with CRV, Heat Treatment
- Long life of using, strong strength,can be used as lever

铝柄布带式机滤芯扳手
Strap Wrench



货号 Item No	规格 Size	总长 length	装盒数 Pc/Box	装箱数 Pc/Carton	毛重 GW/CTN	单支重 NW/PC
M 40701	300mm	305mm	6pcs	36pcs	16.00kg	0.430kg

- 布带长度可根据要求调整,产品总长不包括布带长度
- 能拆装不同尺寸的管状体或异型产品,方便快捷
- Beale can be adjusted for needs
- Can assemble and disassemble different shape of item, easy to be used

三爪式机滤芯扳手
Three Jaw Oil Filter Wrench



货号 Item No	规格 Size	装盒数 Pc/Box	装箱数 Pc/Carton	毛重 GW/CTN	单支重 NW/PC
M 40564	54-116mm	1pc	50pcs	10.00kg	0.35kg

- 三爪双向转动,均匀、灵活、强度高、不易变形
- 特殊设计的齿轮装置,能更牢固的抓紧过滤器;适用于1/2DR.驱动工具或13/16的旋柄
- 可拆卸直径102mm之内的滤清器
- Three claw type filter wrench The 3 claw can rotate smoothly clockwise and anticlockwise and there is no deformation because of its high strength
- The unique designed gear can firmly grasp the filter, suitable for 1/2" DR. ratchet handle or 13/16" spinner handle
- The product can disassemble the filter with the diameter less than 102mm

方形磁力盘
Square Magnetic Disk



货号 Item No	规格 Size	装盒数 Pc/Box	装箱数 Pc/Carton	毛重 GW/CTN	单支重 NW/PC
M 40772	240 x 140mm	10pcs	20pcs	17.00kg	0.750kg

- 材料: 不锈钢430, 磁铁, PVC塑料
- 将磁盘吸在铁板或汽车引擎盖上,能吸附螺丝、螺帽和起子扳手等小件铁制品,以防止跌落或丢失,方便工作,是维修作业的理想工具
- Made of stainless steel 430, magnet and pvc
- Used for adsorb small parts

圆形磁力盘
Circular Magnetic Disk



货号 Item No	规格 Size	装盒数 Pc/Box	装箱数 Pc/Carton	毛重 GW/CTN	单支重 NW/PC
M 40771	150mm	10pcs	40pcs	18.00kg	0.400kg

- 材料: 不锈钢430, 磁铁, PVC塑料
- 将磁盘吸在铁板或汽车引擎盖上,能吸附螺丝、螺帽和起子扳手等小件铁制品,以防止跌落或丢失,方便工作,是维修作业的理想工具
- Made of stainless steel 430, magnet and pvc
- Used for adsorb small parts

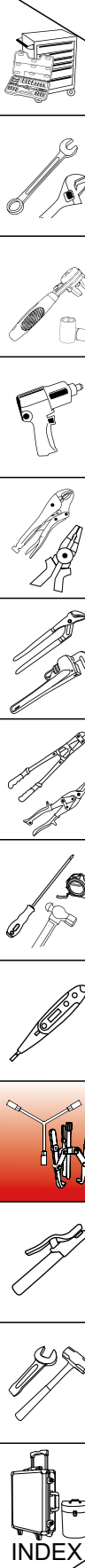

INDEX

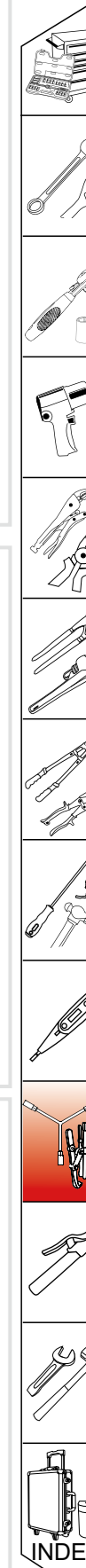

INDEX

火花塞套筒
Spark Plug Socket

CR-V



货号 Item No	规格 Size	总长 length	装盒数 Pc/Box	装箱数 Pc/ Carton	毛重 GW/CTN	单支重 NW/PC
M 47372	10mm(3/8) 系列 16mm	65mm	12pcs	96pcs	9.88kg	0.094kg
M 47373	10mm(3/8) 系列 21mm	65mm	12pcs	96pcs	14.50kg	0.143kg
M 47377	12.5mm(1/2) 系列 16mm	65mm	12pcs	96pcs	11.00kg	0.098kg
M 47378	12.5mm(1/2) 系列 21mm	65mm	12pcs	96pcs	16.00kg	0.155kg

- 优质铬钒钢锻造
- Drop forged with CRV

特长型含氧感应套筒
Extra Long Oxygen Sensor Socket



货号 Item No	规格 Size	装盒数 Pc/Box	装箱数 Pc/ Carton	毛重 GW/CTN	单支重 NW/PC
M 40589	12.5mm(1/2")x22mm	2pcs	60pcs	15.50kg	0.245kg

- 用于车辆空调系统的安装与维修。
- For the installation and maintenance of vehicle air conditioning systems

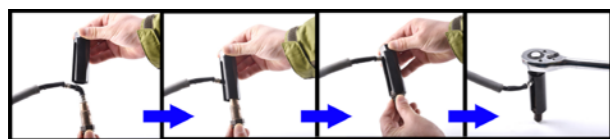

2件套卷式弹簧压缩器
2pcs Coil Spring Clamp set

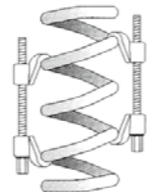
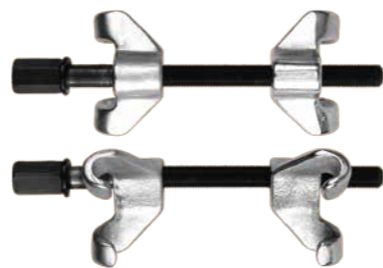

货号 Item No	规格 Size	装盒数 Pc/Box	装箱数 Pc/ Carton	毛重 GW/CTN	单支重 NW/PC
M 40711	270mm	1set	10sets	21.20kg	1.01kg
M 40712	370mm	1set	10sets	21.50kg	1.02kg
M 40713	400mm	1set	10sets	27.00kg	1.27kg

- 1set = 2pcs
- 优质合金钢锻造
- 1/2"DR 方孔, 可配合 1/2"DR 驱动工具或扳手使用
- 钩型件精铸, 热处理 HRC40-45, 表面雾化; 丝杠热处理 HRC35-45, 表面黑色氧化
- Drop forged with high alloy steel
- Can be used together with tools which 1/2" Dr. drive compressor
- Precision casting hook, heat-treated HRC40-45, satin finish, heat-treated screw HRC35-45, black finish

内轴承拉拔器
Pilot Bearing Puller



12-38mm C/V 6150

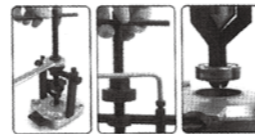

货号 Item No	规格 Size	装盒数 Pc/Box	装箱数 Pc/ Carton	毛重 GW/CTN	单支重 NW/PC
M 40759	12-38mm	1pc	20pcs	18.80kg	0.780kg

- 拉腿铸造 60#
- 适用于内径为 12-38mm 的轴承
- Puller legs, casted with 60# steel
- Applies to bearing which internal dia. is 12-38mm

双叉式球头分离器
Rod End Remove



货号 Item No	拉拔长度 Scope	装盒数 Pc/Box	装箱数 Pc/ Carton	毛重 GW/CTN	单支重 NW/PC
M 40729	200mm	1pc	36pcs	23.18kg	0.690kg

- 优质合金钢锻造
- 适合在狭小空间中使用
- 锤击手柄末端可以分离部件
- Drop forged with high alloy steel
- Suit for using in narrow and small space
- Can separate the parts when hammering the end

5件双叉式球头拉拔器组套
Tie Rod & Ball Joint Tool Kit

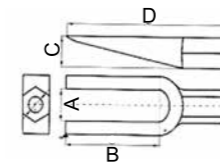

货号 Item No	A (mm)	B (mm)	C (mm)	D (mm)	装盒数 Pc/Box	装箱数 Pc/ Carton	毛重 GW/CTN	每套重量 Weight Per Set	
M 40735	I	17.4mm	66.7mm		1set	10sets	24.00kg	2.300kg	
	II	23.8mm	63.5mm	23.8mm					123.8mm
	III	28.5mm	57.1mm						

- 优质合金钢锻造
- 适合在狭小空间中使用
- 表面黑色电泳: 丝杠、手把热处理HRC35-45, 表面镀锌
- Drop forged with high alloy steel
- Suit for using in narrow and small space
- Black finish; heat-treated screw and handle HRC35-45, zinc plated

横杆球头拉拔器
Tie Rod End Lifter



货号 Item No	工作直径 Working Dia.	拉拔长度 Scope	装盒数 Pc/Box	装箱数 Pc/ Carton	毛重 GW/CTN	单支重 NW/PC
M 40724	18.6mm	135mm	1pc	18pcs	18.36kg	1.080kg

- 优质合金钢锻造
- 用于拆卸给合杆制动装置等部件上的球头关节
- 销轴热处理HRC40-45, 表面雾化; 固定座、活动臂精铸, 表面雾化; 螺栓热处理HRC38-48, 黑色氧化。
- Drop forged with high alloy steel
- Used for disassembling the tie rod end of the brake rigging
- Heat-treated pin HRC40-45, satin finish; precision casting permanent seat and movable arm, satin finish; heat-treated bolt HRC38-48, black finish

球头拉拔器
Tie Rod End Remover



货号 Item No	规格 Size	工作直径 Working Dia.	拉拔长度 Scope	装盒数 Pc/Box	装箱数 Pc/ Carton	毛重 GW/CTN	单支重 NW/PC
M 40717	265mm	17mm	265mm	1pc	20pcs	24.80kg	1.150kg
M 40718	275mm	20mm	275mm	1pc	20pcs	28.00kg	1.300kg

- 优质合金钢锻造
- 用于拆卸给合杆制动装置等部件上的球头关节
- 主架、压块热处理HRC40-45, 表面雾化; 连板热处理HRC40-50, 表面雾化; 螺丝热处理HRC38-48, 黑色氧化。
- Drop forged with high alloy steel
- Used for disassembling the tie rod end of the brake rigging
- Heat-treated body frame and block, satin finish; Heat-treated link HRC 40-50, satin finish; Heat-treated screw HRC38-48, black finish

碟刹调整器
Disc Brake Spreader



货号 Item No	开口量 Opening Capacity	装盒数 Pc/Box	装箱数 Pc/Carton	毛重 GW/CTN	单支重 NW/PC
M 40705	0-65mm	1pc	24pcs	20.78kg	0.880kg

- 用于将新刹车片安装时压回活塞内
- 高级合金锻造
- 1/2"DR 方孔, 可配合 1/2"DR 驱动工具或扳手使用
- 丝杠、导向杆热处理 HRC35-45, 表面镀铬; 压板热处理 HRC35-40, 表面黑色电泳。
- Used for new brake pads installed
- Drop forged with super alloy steel
- Compression range: 0-65mm
- Can be used together with tools which 1/2" Dr. drive compressor
- Heat-treated screw and guide rod, HRC35-45, nickel plated. Heat-treated plate HRC35-40, black electrophoresis finish

单边两爪拉马
Twin Jaw Puller

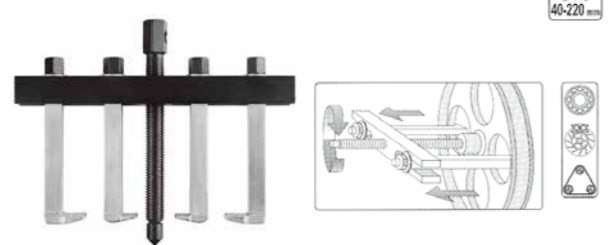

货号 Item No	开口量 Opening Capacity	装盒数 Pc/Box	装箱数 Pc/Carton	毛重 GW/CTN	单支重 NW/PC
M 40767	40-220mm	1pc	10pcs	25.50kg	2.350kg

万能轮毂拉马组套
Universal wheel Hub Puller



货号 Item No	拉拔长度 Scope	装盒数 Pc/Box	装箱数 Pc/Carton	毛重 GW/CTN	每套重量 Weight Per Set
M 40741	200mm	1set	6sets	16.84kg	2.920kg

- 优质铬钒钢锻造
- 主要拆卸汽车轮毂
- 丝杠、顶尖热处理 HRC35-45, 表面黑色氧化;
- 横担表面黑色氧化;
- 拉腿热处理 HRC38-45, 表面雾化;
- 圆盘精铸, 热处理 HRC30-40, 表面雾化。
- Drop forged with CRV
- Used for disassembling the automobile wheel rim
- Heat-treated screw and tip HRC35-45, black finish; cross arm black finish;
- Heat-treated puller legs HRC38-45, satin finish; precision casting disc, Heat-treated HRC30-40, sarin finish

工业级可调式两爪拉马
Two Jaws Puller

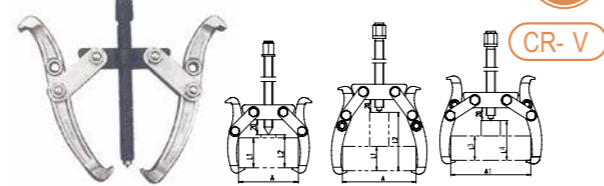

货号 Item No	规格 Size	A(开口量) Opening Capacity	A1(开口量) Opening Capacity	L1(行程) Scope	L2(行程) Scope	L3(行程) Scope	L4(行程) Scope	装盒数 Pc/Box	装箱数 Pc/Carton	毛重 GW/CTN	单支重 NW/PC
M60900	75mm	80mm	/	40mm	44mm	/	/	1pc	40pcs	18.50kg	0.420kg
M60901	100mm	115mm	125mm	40mm	90mm	38mm	60mm	1pc	20pcs	16.00kg	0.750kg
M60902	150mm	160mm	155mm	50mm	140mm	50mm	105mm	1pc	12pcs	21.50kg	1.670kg
M60903	200mm	200mm	215mm	50mm	245mm	50mm	180mm	1pc	6pcs	25.00kg	3.860kg
M60904	250mm	250mm	250mm	80mm	280mm	80mm	215mm	1pc	6pcs	27.00kg	4.270kg
M60905	300mm	300mm	300mm	80mm	290mm	80mm	205mm	1pc	2pcs	19.00kg	8.920kg

- 拉腿采用优质40Cr-V钢材, 杆采用40Cr, 整体锻压而成, 特殊热处理
- 拉杆同样采用40Cr钢材精工而成, 特殊热处理
- Puller jaws made of drop forged 40 Cr-V steel, heat treated
- Puller rod made of precision milled 40 Cr steel, heat treated
- High strength puller rod
- High overall strength

工业级可调式三爪拉马
Three Jaws Puller

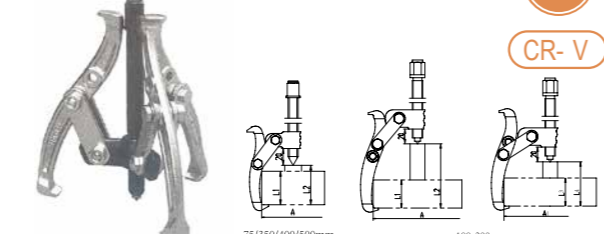

货号 Item No	规格 Size	A(开口量) Opening Capacity	A1(开口量) Opening Capacity	L1(行程) Scope	L2(行程) Scope	L3(行程) Scope	L4(行程) Scope	装盒数 Pc/Box	装箱数 Pc/Carton	毛重 GW/CTN	单支重 NW/PC
M 60911	75mm	75mm	/	40mm	47mm	/	/	1pc	20pcs	12.00kg	0.560kg
M 60912	100mm	120mm	125mm	40mm	87mm	38mm	60mm	1pc	10pcs	11.70kg	1.090kg
M 60913	150mm	175mm	170mm	50mm	135mm	50mm	95mm	1pc	6pcs	15.20kg	2.40kg
M 60914	200mm	220mm	225mm	50mm	245mm	50mm	190mm	1pc	3pcs	17.70kg	5.680kg
M 60915	250mm	250mm	250mm	80mm	280mm	80mm	230mm	1pc	3pcs	19.20kg	6.140kg
M 60916	300mm	300mm	300mm	80mm	290mm	80mm	215mm	1pc	2pcs	26.00kg	12.25kg
M 60917	350mm	360mm	/	100mm	240mm	/	/	1pc	2pcs	24.50kg	11.50kg
M 60918	400mm	400mm	/	100mm	275mm	/	/	1pc	2pcs	28.50kg	13.460kg
M 60919	500mm	505mm	/	100mm	265mm	/	/	1pc	2pcs	38.00kg	18.25kg

- 拉爪的合理型设计, 使其在加力时不致脱落
- 整体铬钒钢锻造, 整支热处理
- Anti-sliding design
- Drop forged with CRV steel, heat treatment

工业级单钩式两爪拉马
Two Jaws Puller

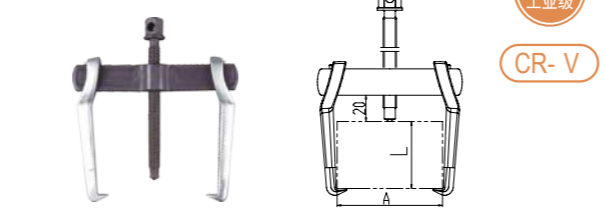

货号 Item No	规格 Size	A(开口量) Opening Capacity	L(行程) Scope	装盒数 Pc/Box	装箱数 Pc/Carton	毛重 GW/CTN	单支重 NW/PC
M 60930	75mm	80mm	50mm	1pc	60pcs	22.30kg	0.36kg
M 60931	100mm	90mm	80mm	1pc	24pcs	18.00kg	0.69kg
M 60932	125mm	120mm	80mm	1pc	24pcs	19.50kg	0.75kg
M 60933	175mm	170mm	130mm	1pc	8pcs	17.50kg	2.04kg
M 60934	225mm	220mm	130mm	1pc	8pcs	19.50kg	2.25kg
M 60935	300mm	285mm	185mm	1pc	4pcs	23.00kg	5.37kg
M 60936	350mm	350mm	185mm	1pc	4pcs	24.50kg	5.83kg

- 拉爪的合理型设计, 使其在加力时不致脱落
- 整体铬钒钢锻造, 整支热处理
- Anti-sliding design
- Drop forged with CRV steel, heat treatment

齿轮拉拔器
Gear Puller Set

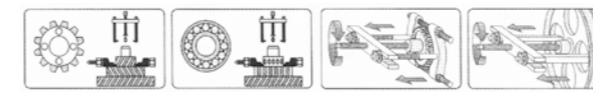

货号 Item No	规格 Size	a. 开口量 Opening Capacity	b. 开口量 Opening Capacity	装盒数 Pc/Box	装箱数 Pc/Carton	毛重 GW/CTN	单支重 NW/PC
M 40763	30-80mm	0-43mm	35-150mm	1set	4sets	17.50kg	4.320kg

- 主要用于齿轮、轴承的拆卸
- For gear bearing removal

分体式液压拉马
Split type Hydraulic Puller



货号 Item No	规格 Size	装盒数 Pc/Box	装箱数 Pc/Carton	毛重 GW/CTN
M 66211	5T	1pc	1pc	9.80kg
M 66212	10T	1pc	1pc	14.00kg
M 66213	15T	1pc	1pc	24.80kg
M 66214	20T	1pc	1pc	25.80kg
M 66215	30T	1pc	1pc	33.00kg
M 66216	50T	1pc	1pc	46.00kg

- 新型液压拉马, 操作方便
- 三爪式和两爪式可根据现场工作需要拆换
- 可自由旋转, 按拉马距离活塞中心点很快可碰到被拉工件的中心点
- 可任意选配泵浦
- 内附三爪, 可调整高低
- New type hydraulic puller, easy to operate
- The product can be switched between two jaws and three jaws according to actual working requirement.
- The product can rotate freely and it can quickly touch the central point of the target object.
- The customer can freely choose the pump model.
- The three jaws are provided and the height can be adjusted freely.

整体式液压拉马
Unitary Hydraulic Puller



货号 Item No	规格 Size	装盒数 Pc/Box	装箱数 Pc/Carton	毛重 GW/CTN	单支重 NW/PC
M 66201	5T	1pc	2pcs	15.00kg	7.20kg
M 66202	10T	1pc	2pcs	22.40kg	10.90kg
M 66203	15T	1pc	2pcs	30.60kg	15.00kg
M 66204	20T	1pc	2pcs	32.50kg	16.00kg
M 66205	30T	1pc	1pc	24.60kg	24.00kg
M 66206	50T	1pc	1pc	34.70kg	32.00kg

- 新型液压拉马使用方便、操作省力
- 特殊热处理顶杆, 经久耐用
- 三爪和二爪可根据现场工作需要拆换
- 拉爪可任意调整高低, 使用更灵活
- The newly designed hydraulic puller is easy to use and labor-saving to operate
- Special heat-treated mandrel for durability
- Three claws and two claws can be dismantled and replaced according to the needs of field work
- The claw can be adjusted to any height, making it more flexible to use

手动液压压线钳
Hydraulic Crimping Pliers



货号 Item No	规格 Size	六角模块配置 Pc/Box	装盒数 Pc/Box	装箱数 Pc/Carton	毛重 GW/CTN	单支重 NW/PC
M 66101	120A(10-120)	10/16/25/35/50/70/95/120mm ²	1pc	4pc	17.40kg	4.18kg
M 66102	240A(16-240)	16/25/35/50/70/95/120/150/185/240mm ²	1pc	4pc	23.00kg	5.58kg
M 66103	300A(16-300)	16/25/35/50/70/95/120/150/185/240/300mm ²	1pc	4pc	25.60kg	5.66kg

- 采用特殊钢压接模块, 坚固耐用
- 压接快速、平稳、操作简单, 安全牢固
- 广泛应用于电力、通信、石油、化工、矿山、冶金及造船等行业。
- Crimping modules made of special steel for durability
- Easy, quick, smooth, and secure crimping
- Widely used in power, communication, petroleum, chemical, mining, metallurgy and shipbuilding industries.

螺旋千斤顶 Screw Jack



货号 Item No	规格 Size	起重高度 Lifting Height	最低高度 Minimum Height	装箱数 Pc/Cartron	毛重 GW/CTN	单支重 NW/PC
M 66321	3.2T	≥ 110	≤ 220	6pcs	23.30kg	3.70kg
M 66322	5T	≥ 130	≤ 250	4pcs	21.00kg	4.80kg
M 66323	8T	≥ 140	≤ 255	4pcs	24.50kg	6.00kg
M 66324	10T	≥ 150	≤ 275	4pcs	26.50kg	6.50kg
M 66325	16T	≥ 180	≤ 320	2pcs	21.00kg	10.0kg
M 66326	20T	≥ 180	≤ 325	2pcs	22.50kg	11.0kg
M 66328	32T	≥ 200	≤ 395	1pc	20.00kg	17.1kg
M 66329	50T	≥ 250	≤ 452	1pc	35.00kg	30.5kg
M 66330	100T	≥ 200	≤ 452	1pc	40.00kg	40.00kg
M 66331	200T	≥ 200	≤ 472	1pc	75.00kg	75.00kg

- 精密铸造，经久耐用，结构紧密，密封性好
- Precision casted, durable, compact and well sealed
- 本产品适用于铁道车辆检修，矿山、建筑工程支撑和一般重物的起升、下降工作
- This product is suitable for railway vehicle maintenance, mining and construction engineering support and other general heavy lifting and lowering works

油压立式千斤顶(可调) Vertical Hydraulic Jack



货号 Item No	规格 Size	起重高度 Lifting Height	最低高度 Minimum Height	调整高度 Adjustment Height	装箱数 Pc/Cartron	毛重 GW/CTN	单支重 NW/PC
M 66301	2T	≥ 80	≤ 148	50	10pcs	23.60kg	2.20kg
M 66302	3.2T	≥ 110	≤ 180	50	5pcs	15.00kg	3.00kg
M 66303	4T	≥ 110	≤ 180	50	5pcs	15.20kg	2.80kg
M 66304	5T	≥ 125	≤ 195	60	5pcs	16.00kg	3.00kg
M 66305	6T	≥ 110	≤ 180	60	5pcs	19.16kg	3.68kg
M 66306	8T	≥ 125	≤ 200	56	4pcs	19.50kg	4.50kg
M 66307	10T	≥ 125	≤ 200	60	4pcs	21.30kg	5.20kg
M 66308	12.5T	≥ 135	≤ 210	60	4pcs	25.20kg	5.80kg
M 66309	16T	≥ 140	≤ 225	60	2pcs	14.70kg	7.35kg
M 66310	20T	≥ 145	≤ 235	60	2pcs	19.50kg	9.50kg
M 66311	32T	≥ 150	≤ 255	60	2pcs	26.70kg	12.70kg
M 66312	50T	≥ 150	≤ 255	50	1pc	20.00kg	18.26kg
M 66313	100T	≥ 180	≤ 335	/	1pc	68.80kg	68.80kg
M 66314	200T	≥ 200	≤ 365	/	1pc	142.00kg	142.00kg

采用美国技术设计，日本 OTC 焊接，德国 BYFORD 喷漆设备精密加工而成。
Designed with technology from USA, welded by OTC JAPAN, painted with byford painting equipment from germany.

高性能 · 长寿命 · 易维修
GOOD PERFORMANCE · LONG LIFETIME · EASY TO MAINTAIN

1. 底座采用优质钢锻打工艺加工，特大底座设计。大大提高了底座的强度及安全性。
The base is drop forged with high quality steel. The extra big base design increases the strength and safety of the base.
2. 集成的液压油道切换系统，可提高千斤顶主体的使用寿命，降低维修成本；内置安全阀，更好的保护使用者。
The integrated hydraulic fluid channel switch system can increase the lifetime of the body of lifting jack and decrease the maintenance cost. The built-in safety valve can protect the user.
3. 焊接千斤顶采用全新的密封系统，可有效延长密封系统的使用寿命。
The welding jack uses the brand-new sealing system which can extend the lifetime of the sealing system.
4. 千斤顶主体采用焊接工艺连接，避免漏油现象的发生，机械性能、抗偏载能力以及使用寿命都得到显著提高。
The main body of lifting jack is connected by welding which can prevent the oil leaking, and the mechanical performance, anti deviated load capability and lifetime of the lifting jack is remarkably promoted.
5. 调整螺杆采用优质钢锻打加工，并作调质处理，增加螺杆强度；螺杆头采用新型 防滑设计，防滑效果更加明显。
The adjustment screw is made of drop forged steel which can increase the strength. The screw head adopts the anti-slip design which can avoid slipping.

- 安全阀结构设计，当承载达到额定吨位的1.15倍时，安全阀自动开启进行自动卸载，承载不再上升，保证使用的安全性。
- 头部防滑面设计，经特殊热处理，使产品在使用中不易发生滑脱、顶弯、折断等现象。
- 主体采用全自动焊接工艺进行连接，避免漏油现象的发生，整体机械强度和抗偏载能力都得到显著的提高。
- Safety valve design. When the load reaches 1.15 times the rated tonnage, the safety valve will automatically open for automatic unloading, and the load will no longer rise, ensuring the safety of use.
- Anti-skid surface design. Special heat treated surface to prevent slippage, bend and break during use.
- The main body is constructed by a fully automatic welding process to avoid oil leakage, and the overall mechanical strength and eccentric load resistance are significantly improved.

日式手拉葫芦 Japanese Type Chain Block

Japanese Type Chain Block

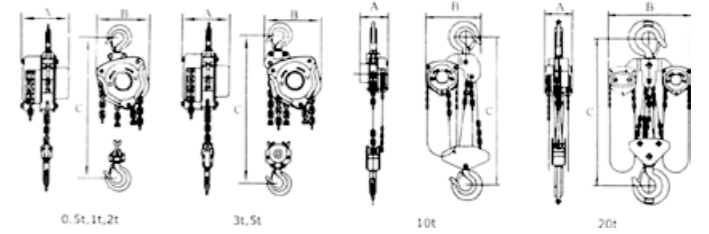

货号 Item No	规格 Size	额定载荷 Rated Load	装箱数 Pc/Cartron	毛重 GW/CTN	单支重 NW/PC
M 66611	1Tx3m	1T	1pc	12.00kg	12.00kg
M 66614	1Tx6m	1T	1pc	17.00kg	17.00kg
M 66621	2Tx3m	2T	1pc	19.00kg	19.00kg
M 66624	2Tx6m	2T	1pc	24.50kg	24.50kg
M 66631	3Tx3m	3T	1pc	23.80kg	23.80kg
M 66634	3Tx6m	3T	1pc	35.30kg	35.30kg
M 66641	5Tx3m	5T	1pc	43.30kg	43.30kg
M 66644	5Tx6m	5T	1pc	56.00kg	56.00kg
M 66651	10Tx3m	10T	1pc	75.00kg	75.00kg
M 66654	10Tx6m	10T	1pc	95.00kg	95.00kg

额定载荷 Rated Load	1T	2T	3T	5T
标准升起高度 (m) Standard Lifting Height	2.5	3	3	3
试验载荷 (Kn) Test Load	12.5	25	37.5	62.5
满载时手拉力 (N) Hand Pulling Force When Fully Loaded	309	360	340	410
起重链条行数 Number of Rows for Chains Inside	1	1	2	2
起重链条直径 (mm) Diameter of Lifting Chains	6	8	8	10
起重高度每增加 1 米增加的重量 (kg) Increased Weight as the Lifting Height is Increased by 1 Meter	1.7	2.3	3.7	5.6

注意事项

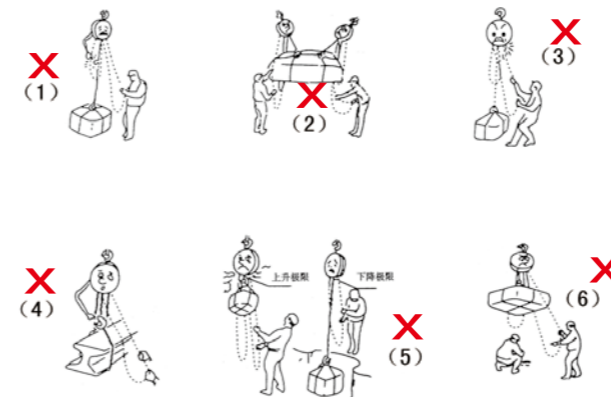

1. 严禁链条扭曲时使用
 2. 严禁用两台或两台以上葫芦同时起吊一重物
 3. 发现手拉力大于正常拉力时，应立即停止使用进行检查，不可猛拉，更不允许增人硬拉
 4. 严禁将重物吊在吊钩的尖端或将下吊钩回扣到起重链条上起吊重物
 5. 提升和下降重物时均不得超过上、下行程的极限
 6. 严禁人员在起吊的重物下工作或行走
1. Forbidden to use when the chain is twisted
 2. Forbidden to use two or more hoists to lift the heavy object.
 3. When the hand pulling force is larger than the normal force, stop using and check the equipment immediately. Forbidden to twitch or ask more people to pull together.
 4. Forbidden to hang the heavy object on the tip of the hook or hook the lower hook to the lifting chain to lift the heavy object.
 5. Lift or lower the heavy object within the limit of distance of run.
 6. Forbidden to work or walk below the lifted heavy object.

园林类、焊割类、建筑装潢类工具

Garden Tools / Welding Tools / Building & Decorating Tools

园林工具	
管子	143
焊割类	
电焊钳	144
建筑装潢类	
磁性线坠	145
玻璃吸盘	145
拉铆枪及替换刀片	146
Garden tools	
Tube	143
Welding Tools	
Welding Clamp	144
Building & Decorating Tools	
Magnetic Plumb Setter	145
Suction Plate	145
Riveters and Replace Jaws	146

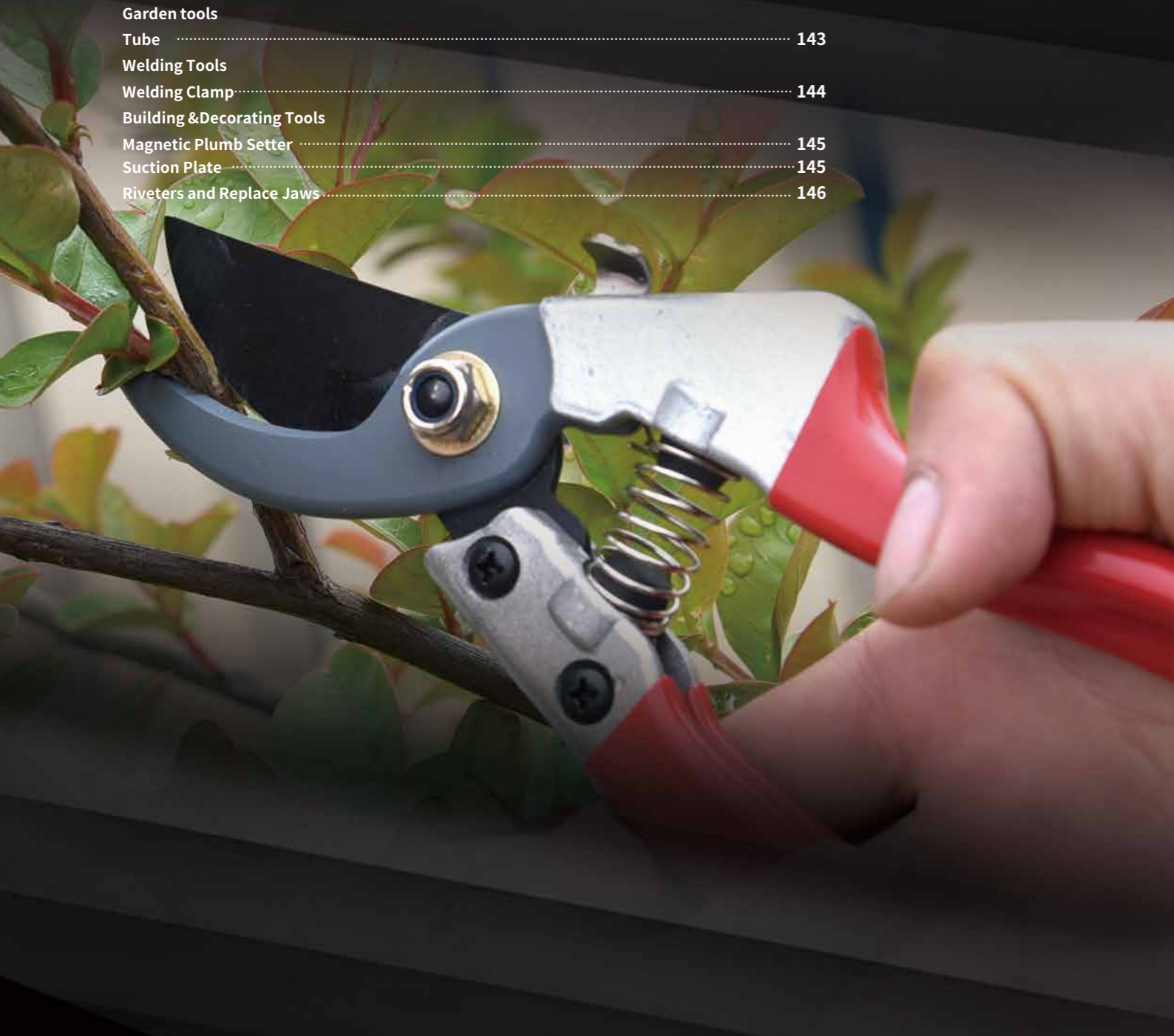

精品剪枝剪 Professional Secateurs



货号 Item No	规格 Size	装盒数 Pc/Box	装箱数 Pc/Carton	毛重 GW/CTN	单支重 NW/PC
M 60100	200mm(8")	6pcs	60pcs	14.40kg	0.225kg

- SK5刀片, 刀片锋利, 使用轻便
- △ 本品属于易耗品, 不属于终身保用范围
- SK5 blades, sharp and convenient
- △ No warranty as consumables



焊接工作台 Welding Workbench

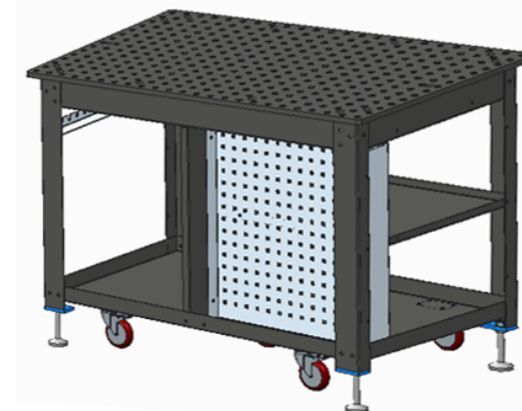

货号: M08230
Item No: M08230
规格: 1200x750x850mm
Size: 1200x750x850mm

平整度: 0.3mm/1000mm Flatness:	孔径: 16mm+0.005/-0.000 Aperture:
孔 距: 50mm±0.025 Hole distance:	板厚: 16mm±0.1 Plate thickness:
摩擦系数: 0.37 Coefficient of friction:	可耐高温: 371°C Temperature resistance:

- 工作台面可进行选择性QPQ盐浴复合热处理。
- QPQ处理过程是一种机械抛光后再进行盐浴复合氧化热处理技术。
- 主要优点包括: 防焊渣、表面硬度高、耐磨、耐高温等。
- 表面化合物层厚度: 0.01mm-0.02mm
- The work surface can be subjected to selective QPQ salt bath composite heat treatment.
- The QPQ process is a heat treatment technique of mechanical polishing followed by salt bath composite oxidation.
- The main advantages include: spatter resistance, high surface hardness, wear resistance and high temperature resistance.
- Surface compound layer thickness: 0.01mm-0.02mm

氧气乙炔双联管 Oxygen Acetylene Tube with Double Pipe

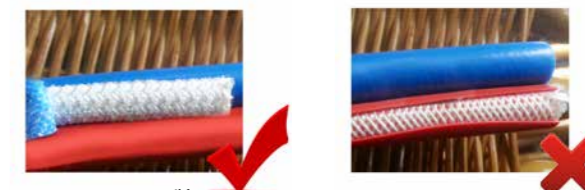

MAXPOWER品牌
加强型壁厚
双层涤纶丝紧密编织
三层胶质高温强力胶合

普通市面材质
多为缠绕丝型

货号 Item No	规格 Size	总长 length	装箱数 Pc/Carton	毛重 GW/CTN
M 62561	8mm	30m	1pc	7.00kg
M 62562	8mm	100m	1pc	23.00kg

- 耐高压性能好, 三层胶质高温强力融合, 工作压力30kg/cm², 爆破力达到120kg/cm²。
- 采用最先进的工艺配方, 使用寿命是普通橡胶管五倍以上。
- 采用独特配方材料, 使软管具有耐油、耐30%浓度酸碱的优越性能。
- 工作温度-50度至85度, 零下50度不开裂。
- 具有良好的阻燃性能及耐磨损性。
- High pressure resistant, extra thick tube wall, 3-layer colloid fused in high temperature, work pressure up to 30kg/cm² and the explosive force up to 120kg/cm².
- Produced by the most advanced technique and its life time is 5 times than the normal rubber tube.
- Produced with the special recipe and material which make this product oil-resistant and 30% Acid-Alkaline resistant.
- Work temperature is from -50 to 85 degree and it doesn't break at -50 degree.
- The product has good ability of flame retardance and abrasion resistance.

★售完下架

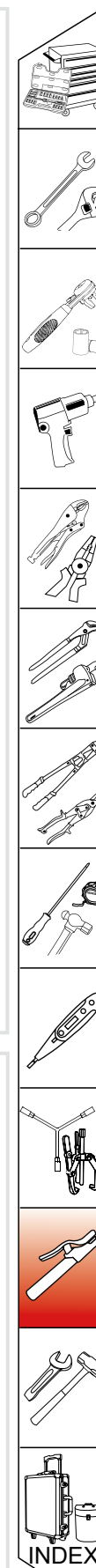

焊工锤
Welding Hammer



货号 Item No	规格 Size	装盒数 Pc/Box	装箱数 Pc/Carton	毛重 GW/CTN	单支重 NW/PC
M 62064	285mm	6pcs	48pcs	26.00kg	0.50kg

- 弹簧手柄设计, 敲击时有缓冲力, 使用安全方便
- Spring handle design, buffer when tapping, safe and convenient to use

螺旋式电焊钳
Welding Clamp



货号 Item No	规格 Size	装盒数 Pc/Box	装箱数 Pc/Carton	毛重 GW/CTN	单支重 NW/PC
M 62042	300A	1pc	30pcs	17.00kg	0.533kg a.
M 62043	500A	1pc	30pcs	19.50kg	0.600kg a.
M 62044	800A	1pc	30pcs	22.80kg	0.725kg b.

- 加厚铜质钳体, 钳体锻造 加深牙齿, 夹紧焊条
- 外型美观, 接线方便, 不烫手, 适合长时间连续工作
- Wiring convenient, suitable for long time continuous work

不锈钢割炬
Stainless Steel Cutting Torch



货号 Item No	规格 Size	装盒数 Pc/Box	装箱数 Pc/Carton	毛重 GW/CTN	单支重 NW/PC
M 62152	G01-30	1pc	15pcs	12.00kg	0.770kg
M 62153	G01-100	1pc	15pcs	13.50kg	0.870kg

- 通气管采用不锈钢材料, 强度高, 不宜变形
- 割炬质量好, 流量大, 同时不锈钢管不氧化, 能保持表面清洁
- 焊接部件全部采用银焊条焊接, 保证了焊接部位的可靠性
- The torch pipe is made of stainless steel which has high strength and is not easy to deform
- The quality of the cutting torch is good with large flow and the stainless torch pipe won't oxidize so the surface keeps clean
- The welded part is welded with silver welding rod which guarantee the reliability of the welding

压板式电焊钳
Welding Clamp



货号 Item No	规格 Size	装盒数 Pc/Box	装箱数 Pc/Carton	毛重 GW/CTN	单支重 NW/PC
M 62035	800A	1pc	30pcs	21.30kg	0.667kg

- 加厚铜质钳体, 钳体锻造 加深牙齿, 夹紧焊条
- 本品属易耗品, 不属于终身保用范围
- This product is a consumable item, excluded from Maxpower's lifetime warranty.



磁性线坠
Magnetic Plumb Setter



货号 Item No	规格 Size	装盒数 Pc/Box	装箱数 Pc/Carton	毛重 GW/CTN	单支重 NW/PC
M 60330	3m x 300g	6pcs	36pcs	17.30kg	0.444kg
M 60331	6m x 400g	6pcs	36pcs	23.00kg	0.625kg

- 具有锁扣功能, 强磁, 收线自如, 快速定位
- 采用磁能优良的磁磁石, 实现了小型化、轻量化, 磁性高达2000高斯
- 具有自动平衡调节功能: 木材用插外, 钢材用磁石, 混凝土等用挂钩来固定
- 采用黄色醒目丝线, 测量方便, 重锤能够快速停摆
- With lock function, strong magnetic, thread can be taken back easily, quick positioning
- The product uses high quality rubidium magneto, the advantage of which is small and light but strong magnetic up to 2000 gauss
- With the function of automatically balancing adjustment, For wood, it can be fixed by inserting, for steel by magnet and for concrete by hook
- The product uses yellow thread, easy to measure and the plummet can stand still quickly

三爪玻璃吸盘
Three Claws Glass Sucker



货号 Item No	规格 Size	装盒数 Pc/Box	装箱数 Pc/Carton	毛重 GW/CTN	单支重 NW/PC
M 60245	120-3	1pc	10pcs	12.2kg	1.200kg

- 铝合金手柄, 天然橡胶吸盘, 吸力强, 每个吸盘可提 50kg 重物
- 本品属于易耗品, 不属于终身保用范围
- Aluminum handle ,plate made of natural rubber pad, strong suction, each sucker can suck 50kg
- No warranty as consumables

活动式两爪玻璃吸盘
Movable Double Claws Glass Sucker



★售完下架

货号 Item No	规格 Size	装盒数 Pc/Box	装箱数 Pc/Carton	毛重 GW/CTN	单支重 NW/PC
M 60248	150-2	1pc	10pcs	18.70kg	1.700kg

- 手柄优质钢材制做, 吸盘可活动, 能抓吸特殊工件加大天然橡胶吸盘, 吸力强, 每个吸盘可提 75kg 重物
- 本品属于易耗品, 不属于终身保用范围
- Handle is made of superior steel, the plate can be movable, each sucker can suck 75kg
- No warranty as consumables

双爪玻璃吸盘
Double Claws Glass Sucker



货号 Item No	规格 Size	装盒数 Pc/Box	装箱数 Pc/Carton	毛重 GW/CTN	单支重 NW/PC
M 60242	120-2	1pc	20pcs	17.90kg	0.800kg

- 铝合金手柄, 天然橡胶吸盘, 吸力强, 每个吸盘可提 50kg 重物
- 本品属于易耗品, 不属于终身保用范围
- Aluminum handle ,plate made of natural rubber pad, strong suction,each sucker can suck 50kg
- No warranty as consumables

活动式三爪玻璃吸盘
Movable Three Claws Glass Sucker



★售完下架

货号 Item No	规格 Size	装盒数 Pc/Box	装箱数 Pc/Carton	毛重 GW/CTN	单支重 NW/PC
M 60251	150-3	1pc	10pcs	25.00kg	2.300kg

- 手柄优质钢材制做, 吸盘可活动, 能抓吸特殊工件加大天然橡胶吸盘, 吸力强, 每个吸盘可提 75kg 重物
- 本品属于易耗品, 不属于终身保用范围
- Handle is made of superior steel, the plate can be movable, each sucker can suck 75kg
- No warranty as consumables

单爪玻璃吸盘
Single Claws Glass Sucker



货号 Item No	规格 Size	装盒数 Pc/Box	装箱数 Pc/Carton	毛重 GW/CTN	单支重 NW/PC
M 60239	120-1	1pc	20pcs	9.7kg	0.450kg

- 铝合金手柄, 天然橡胶吸盘, 吸力强, 每个吸盘可提 50kg 重物
- 本品属于易耗品, 不属于终身保用范围
- Aluminum handle ,plate made of natural rubber pad, strong suction, each sucker can suck 50kg
- No warranty as consumables

省力型双把拉铆枪
Riveter

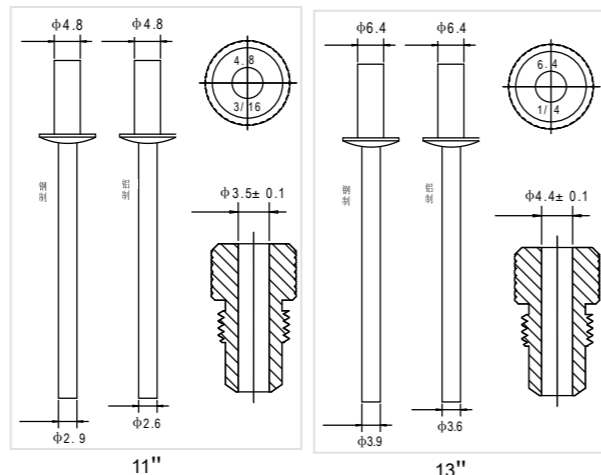

搭配使用零部件



省力型双把拉铆枪爪片
Jaws for Riveters

货号 Item No	装盒数 Pc/Box	装箱数 Pc/Carlotn	毛重 GW/CTN	单支重 NW/PC
M 99551	10pcs	500pcs	5.00kg	0.010kg

△ 本品属于易耗品, 不属于终身保用范围
△ No warranty as consumables

11"用于2.4,3.2, 4.0, 4.8mm的铝铆钉
13"用于3.2, 4.0, 4.8, 6.4, 6.0mm的铝铆钉

货号 Item No	规格 Size	铆钉直径 Φ	装盒数 Pc/Box	装箱数 Pc/Carlotn	毛重 GW/CTN	单支重 NW/PC
M 60310	11"	4.8mm	1pc	20pcs	14.80kg	0.675kg
M 60311	13"	6.4mm	1pc	16pcs	18.60kg	1.063kg

- 总长度缩小, 适合在狭小空间使用
- 省力结构设计, 省力约40%
- 3片式铬铝合金钢爪片, 使用寿命长
- 防震设计, 消除工作时铆枪对手臂的震动
- 集钉瓶设计, 防止意外及保持环境清洁
- △ 本品属于易耗品, 不属于终身保用范围
- △ Suitable to be used in narrow place · Force saving, can save 40% force
- △ Long using life
- △ No warranty as consumables



INDEX

防爆类工具

Non-Sparking Brass Tools

防爆铍青铜扳手	148
防爆铍敲击扳手	149
防爆铍青铜锤子	149
Non-Sparking Brass Wrench	148
Non-Sparking Brass Striking Wrench	149
Non-Sparking Brass Hammer	149



防爆铍青铜活扳手
Non-Sparking Brass Adjustable Wrench



货号 Item No.	规格 Size	长度 Length	装盒数 Pc/Box	装箱数 Pc/Carton	毛重 GW/CTN	单支重 NW/PC
M 32010	6" (150mm)	150mm	6pcs	120pcs	17.20kg	0.135kg
M 32011	8" (200mm)	200mm	6pcs	60pcs	17.86kg	0.281kg
M 32012	10" (250mm)	250mm	5pcs	40pcs	18.60kg	0.440kg
M 32013	12" (300mm)	300mm	5pcs	20pcs	15.40kg	0.720kg
M 32014	15" (375mm)	375mm	2pcs	12pcs	17.92kg	1.410kg
M 32015	18" (450mm)	450mm	2pcs	6pcs	14.56kg	2.261kg
M 32016	24" (600mm)	600mm	2pcs	6pcs	29.23kg	4.705kg

·采用优质铍青铜材质整体锻造
·密度高，韧性好，使用寿命长，具有优越的防磁性能
·在易燃易爆环境中，能有效防止工具与工作物相互摩擦碰撞产生火花，避免可燃性爆炸
·It is integrally forged with high-quality beryllium bronze material.
·High density, good toughness, long service life and superior antimagnetic performance.
·In a flammable and explosive environment, it can effectively prevent the tool and the work object from colliding and rubbing against each other to generate sparks and avoid flammable explosions.

防爆铍青铜双头梅花扳手
Non-Sparking Brass Double Box End Wrench



货号 Item No.	规格 Size	长度 Length	装盒数 Pc/Box	装箱数 Pc/Carton	毛重 GW/CTN	单支重 NW/PC
M 32208	5.5x7mm	115mm	10pcs	400pcs	9.80kg	0.022kg
M 32209	8x10mm	130mm	10pcs	400pcs	23.00kg	0.055kg
M 32210	9x11mm	140mm	10pcs	200pcs	15.00kg	0.070kg
M 32211	10x12mm	140mm	10pcs	200pcs	18.00kg	0.085kg
M 32212	12x14mm	160mm	10pcs	100pcs	16.00kg	0.150kg
M 32213	14x17mm	220mm	10pcs	80pcs	17.40kg	0.205kg
M 32214	17x19mm	250mm	10pcs	80pcs	19.00kg	0.225kg
M 32215	19x22mm	280mm	5pcs	50pcs	16.50kg	0.310kg
M 32216	22x24mm	310mm	5pcs	50pcs	23.75kg	0.455kg
M 32217	24x27mm	340mm	5pcs	30pcs	16.60kg	0.520kg
M 32218	27x30mm	360mm	5pcs	30pcs	22.15kg	0.705kg
M 32219	30x32mm	380mm	4pcs	16pcs	13.88kg	0.805kg
M 32220	32x34mm	400mm	4pcs	16pcs	18.28kg	1.080kg
M 32221	32x36mm	405mm	4pcs	16pcs	19.32kg	1.145kg
M 32222	34x36mm	420mm	4pcs	16pcs	19.64kg	1.165kg
M 32223	36x41mm	445mm	5pcs	10pcs	17.00kg	1.600kg
M 32224	41x46mm	470mm	5pcs	10pcs	17.00kg	1.600kg
M 32225	46x50mm	490mm	4pcs	8pcs	17.64kg	2.080kg
M 32226	50x55mm	510mm	4pcs	8pcs	21.64kg	2.580kg

·采用优质铍青铜材质整体锻造
·密度高，韧性好，使用寿命长，具有优越的防磁性能
·在易燃易爆环境中，能有效防止工具与工作物相互摩擦碰撞产生火花，避免可燃性爆炸
·It is integrally forged with high-quality beryllium bronze material.
·High density, good toughness, long service life and superior antimagnetic performance.
·In a flammable and explosive environment, it can effectively prevent the tool and the work object from colliding and rubbing against each other to generate sparks and avoid flammable explosions.

防爆铍青铜双头呆扳手
Non-Sparking Brass Double Open End Wrench



货号 Item No.	规格 Size	长度 Length	装盒数 Pc/Box	装箱数 Pc/Carton	毛重 GW/CTN	单支重 NW/PC
M 32247	6x7mm	92mm	10pcs	400pcs	11.00kg	0.025kg
M 32248	8x10mm	100mm	10pcs	400pcs	14.60kg	0.034kg
M 32249	9x11mm	110mm	10pcs	200pcs	11.00kg	0.050kg
M 32250	10x12mm	120mm	10pcs	200pcs	13.00kg	0.060kg
M 32251	12x14mm	130mm	10pcs	200pcs	16.00kg	0.075kg
M 32252	14x17mm	150mm	10pcs	100pcs	13.00kg	0.120kg
M 32253	17x19mm	170mm	10pcs	100pcs	16.00kg	0.150kg
M 32254	19x22mm	185mm	5pcs	50pcs	12.00kg	0.220kg
M 32255	22x24mm	210mm	5pcs	50pcs	16.60kg	0.312kg
M 32256	24x27mm	230mm	5pcs	50pcs	18.25kg	0.345kg
M 32257	27x30mm	250mm	5pcs	30pcs	15.55kg	0.485kg
M 32258	30x32mm	265mm	5pcs	30pcs	19.30kg	0.610kg
M 32259	32x34mm	270mm	4pcs	24pcs	20.56kg	0.815kg
M 32260	32x36mm	300mm	5pcs	20pcs	18.70kg	0.885kg
M 32261	34x36mm	300mm	5pcs	20pcs	18.70kg	0.885kg
M 32262	36x41mm	330mm	6pcs	12pcs	17.20kg	1.350kg
M 32263	41x46mm	355mm	5pcs	10pcs	16.90kg	1.590kg
M 32264	46x50mm	370mm	4pcs	8pcs	17.40kg	2.050kg
M 32265	50x55mm	385mm	4pcs	8pcs	18.28kg	2.160kg

·采用优质铍青铜材质整体锻造
·密度高，韧性好，使用寿命长，具有优越的防磁性能
·在易燃易爆环境中，能有效防止工具与工作物相互摩擦碰撞产生火花，避免可燃性爆炸
·It is integrally forged with high-quality beryllium bronze material.
·High density, good toughness, long service life and superior antimagnetic performance.
·In a flammable and explosive environment, it can effectively prevent the tool and the work object from colliding and rubbing against each other to generate sparks and avoid flammable explosions.

防爆铍青铜两用扳手
Non-Sparking Brass Combination Wrench



货号 Item No.	规格 Size	长度 Length	装盒数 Pc/Box	装箱数 Pc/Carton	毛重 GW/CTN	单支重 NW/PC
M 32286	6mm	105mm	10pcs	400pcs	9.80kg	0.022kg
M 32287	7mm	105mm	10pcs	400pcs	9.80kg	0.022kg
M 32288	8mm	105mm	10pcs	400pcs	15.00kg	0.035kg
M 32289	9mm	130mm	10pcs	200pcs	11.00kg	0.050kg
M 32290	10mm	130mm	10pcs	200pcs	12.00kg	0.055kg
M 32291	11mm	145mm	10pcs	200pcs	16.00kg	0.075kg
M 32292	12mm	145mm	10pcs	200pcs	16.00kg	0.075kg
M 32293	13mm	165mm	10pcs	100pcs	13.00kg	0.120kg
M 32294	14mm	165mm	10pcs	100pcs	13.00kg	0.120kg
M 32295	15mm	185mm	10pcs	100pcs	17.00kg	0.160kg
M 32296	17mm	185mm	10pcs	100pcs	15.00kg	0.140kg
M 32297	18mm	210mm	10pcs	100pcs	21.00kg	0.200kg
M 32298	19mm	210mm	10pcs	100pcs	21.00kg	0.200kg
M 32299	21mm	240mm	5pcs	50pcs	12.50kg	0.230kg
M 32300	22mm	240mm	5pcs	50pcs	12.50kg	0.230kg
M 32301	24mm	260mm	5pcs	50pcs	13.00kg	0.240kg
M 32302	27mm	285mm	5pcs	50pcs	21.50kg	0.410kg
M 32303	30mm	310mm	5pcs	20pcs	12.00kg	0.550kg
M 32304	32mm	320mm	5pcs	20pcs	14.00kg	0.650kg
M 32305	34mm	360mm	5pcs	20pcs	18.00kg	0.850kg
M 32306	36mm	360mm	5pcs	20pcs	18.80kg	0.890kg
M 32307	38mm	430mm	5pcs	10pcs	15.40kg	1.440kg
M 32308	41mm	430mm	5pcs	10pcs	15.40kg	1.440kg
M 32309	46mm	480mm	5pcs	10pcs	19.90kg	1.890kg

·采用优质铍青铜材质整体锻造
·密度高，韧性好，使用寿命长，具有优越的防磁性能
·在易燃易爆环境中，能有效防止工具与工作物相互摩擦碰撞产生火花，避免可燃性爆炸
·It is integrally forged with high-quality beryllium bronze material.
·High density, good toughness, long service life and superior antimagnetic performance.
·In a flammable and explosive environment, it can effectively prevent the tool and the work object from colliding and rubbing against each other to generate sparks and avoid flammable explosions.

防爆铍青铜德式敲击梅花扳手
Non-Sparking Brass Box End Striking Wrench



货号 Item No.	规格 Size	长度 Length	装盒数 Pc/Box	装箱数 Pc/Carton	毛重 GW/CTN	单支重 NW/PC
M 32108	27mm	175mm	5pcs	40pcs	15.00kg	0.350kg
M 32109	30mm	185mm	5pcs	40pcs	20.00kg	0.475kg
M 32110	32mm	185mm	5pcs	40pcs	19.60kg	0.465kg
M 32111	34mm	200mm	5pcs	20pcs	11.80kg	0.540kg
M 32112	36mm	205mm	5pcs	20pcs	12.60kg	0.580kg
M 32113	38mm	215mm	5pcs	20pcs	14.60kg	0.680kg
M 32114	41mm	225mm	2pcs	20pcs	16.10kg	0.755kg
M 32115	46mm	235mm	2pcs	20pcs	20.80kg	0.990kg
M 32116	50mm	250mm	1pc	10pcs	12.50kg	1.150kg
M 32117	55mm	265mm	1pc	10pcs	15.40kg	1.440kg
M 32118	60mm	274mm	1pc	10pcs	17.20kg	1.620kg
M 32119	65mm	298mm	1pc	10pcs	21.00kg	2.000kg
M 32120	70mm	320mm	1pc	6pcs	15.64kg	2.440kg
M 32121	75mm	326mm	1pc	6pcs	19.06kg	3.010kg
M 32122	80mm	350mm	1pc	6pcs	22.60kg	3.600kg

·采用优质铍青铜材质整体锻造
·密度高，韧性好，使用寿命长，具有优越的防磁性能
·在易燃易爆环境中，能有效防止工具与工作物相互摩擦碰撞产生火花，避免可燃性爆炸
·It is integrally forged with high-quality beryllium bronze material.
·High density, good toughness, long service life and superior antimagnetic performance.
·In a flammable and explosive environment, it can effectively prevent the tool and the work object from colliding and rubbing against each other to generate sparks and avoid flammable explosions.

防爆铍青铜德式敲击呆扳手
Non-Sparking Brass Open End Striking Wrench



货号 Item No.	规格 Size	长度 Length	装盒数 Pc/Box	装箱数 Pc/Carton	毛重 GW/CTN	单支重 NW/PC
M 32143	27mm	180mm	5pcs	40pcs	15.80kg	0.370kg
M 32144	30mm	190mm	5pcs	40pcs	18.40kg	0.435kg
M 32145	32mm	190mm	5pcs	20pcs	11.30kg	0.515kg
M 32146	36mm	210mm	5pcs	20pcs	16.00kg	0.750kg
M 32147	38mm	225mm	5pcs	20pcs	18.40kg	0.870kg
M 32148	41mm	225mm	2pcs	20pcs	18.00kg	0.850kg
M 32149	46mm	245mm	1pc	10pcs	13.90kg	1.290kg
M 32150	50mm	270mm	1pc	10pcs	16.30kg	1.530kg
M 32151	55mm	300mm	1pc	10pcs	22.80kg	2.180kg
M 32152	60mm	310mm	1pc	6pcs	15.25kg	2.375kg
M 32153	65mm	340mm	1pc	6pcs	22.48kg	3.580kg
M 32154	70mm	375mm	1pc	4pcs	18.72kg	4.430kg
M 32155	75mm	375mm	1pc	4pcs	20.80kg	4.950kg
M 32156	80mm	405mm	1pc	4pcs	24.20kg	5.800kg

·采用优质铍青铜材质整体锻造
·密度高，韧性好，使用寿命长，具有优越的防磁性能
·在易燃易爆环境中，能有效防止工具与工作物相互摩擦碰撞产生火花，避免可燃性爆炸
·It is integrally forged with high-quality beryllium bronze material.
·High density, good toughness, long service life and superior antimagnetic performance.
·In a flammable and explosive environment, it can effectively prevent the tool and the work object from colliding and rubbing against each other to generate sparks and avoid flammable explosions.

防爆铍青铜包塑柄圆头锤
Non-Sparking Brass Ball Pein Hammer



货号 Item No.	规格 Size	长度 Length	装盒数 Pc/Box	装箱数 Pc/Carton	毛重 GW/CTN	单支重 NW/PC
M 32438	0.5LB(0.22kg)	280mm	6pcs	24pcs	10.67kg	0.403kg
M 32439	0.75LB(0.34kg)	280mm	6pcs	24pcs	13.05kg	0.502kg
M 32440	1LB(0.45kg)	300mm	6pcs	12pcs	9.16kg	0.680kg
M 32441	1.5LB(0.68kg)	300mm	6pcs	12pcs	12.4kg	0.950kg
M 32442	2LB(0.91kg)	350mm	4pcs	8pcs	10.64kg	1.205kg
M 32443	2.5LB (1.13kg)	370mm	4pcs	8pcs	12.76kg	1.470kg

·采用优质铍青铜材质整体锻造
·密度高，韧性好，使用寿命长，具有优越的防磁性能
·在易燃易爆环境中，能有效防止工具与工作物相互摩擦碰撞产生火花，避免可燃性爆炸
·It is integrally forged with high-quality beryllium bronze material.
·High density, good toughness, long service life and superior antimagnetic performance.
·In a flammable and explosive environment, it can effectively prevent the tool and the work object from colliding and rubbing against each other to generate sparks and avoid flammable explosions.

防爆铍青铜包塑柄八角锤
Non-Sparking Brass Sledge Hammer



货号 Item No.	规格 Size	长度 Length	装盒数 Pc/Box	装箱数 Pc/Carton	毛重 GW/CTN	单支重 NW/PC
M 32408	2LB(0.9KG)	300mm	6pcs	36pcs	39.16kg	1.06kg
M 32409	3LB(1.4KG)	320mm	4pcs	8pcs	13.24kg	1.53kg
M 32410	4LB(1.8KG)	350mm	4pcs	8pcs	17.40kg	2.05kg
M 32411	6LB(2.7KG)	900mm	/	4pcs	15.44kg	3.61kg
M 32412	8LB(3.6KG)	900mm	/	4pcs	19.04kg	4.51kg
M 32413	10LB(4.5KG)	900mm	/	4pcs	22.24kg	5.31kg
M 32414	12LB(5.4KG)	900mm	/	2pcs	13.62kg	6.31kg
M 32415	14LB(6.3KG)	900mm	/	2pcs	14.82kg	6.91kg
M 32416	16LB(7.2KG)	900mm	/	2pcs	17.22kg	8.11kg
M 32417	18LB(8.1KG)	900mm	/	2pcs	19.02kg	9.01kg

·采用优质铍青铜材质整体锻造
·密度高，韧性好，使用寿命长，具有优越的防磁性能
·在易燃易爆环境中，能有效防止工具与工作物相互摩擦碰撞产生火花，避免可燃性爆炸
·It is integrally forged with high-quality beryllium bronze material.
·High density, good toughness, long service life and superior antimagnetic performance.
·In a flammable and explosive environment, it can effectively prevent the tool and the work object from colliding and rubbing against each other to generate sparks and avoid flammable explosions.

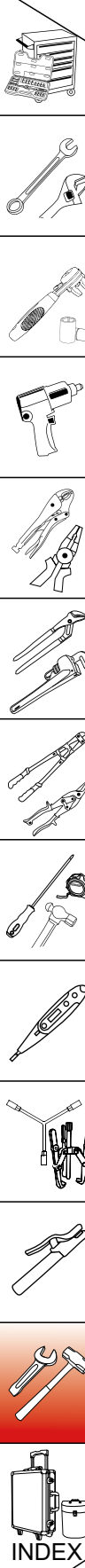

INDEX

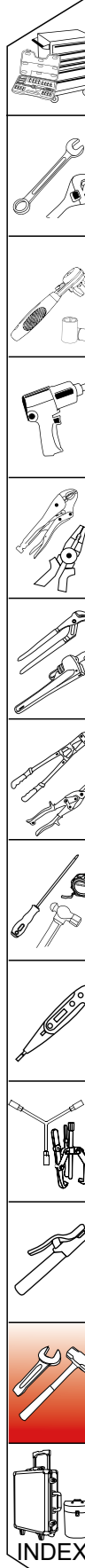

INDEX

家装维修工具组套 Home maintenance 68PCS



货号: M07748

- 快速棘轮两用扳手 13,14,17,19mm
- 耐油柄穿芯十字螺丝批 PH2x100mm
- 耐油柄穿芯一字螺丝批 6x100mm
- 5件套直柄麻花钻
- 多功能折叠刀
- 螺丝批组套
- 6.3mm系列65mm长气动双头旋具头 PH2xPH2
- 双面高档鲁班钢卷尺 5M
- 数显测电笔 3.5x140mm
- 充电式冲击扳手 880 N.m
- 冲击扳手充电器
- 批头连接杆 60mm
- 羊角锤 16oz
- 批头组套 十字PH0, PH1, PH2, PH3 一字SL3, SL4, SL5, SL6 花型T15, T20, T25, T30
- 工业级棘轮扳手 12.5mm
- 软向接杆 290mm
- 大R角套筒 10,11,12,13,14,16, 17,18,19mm
- VDE绝缘尖嘴钳 160mm
- VDE绝缘剥线钳 160mm
- VDE绝缘斜嘴钳 200mm
- VDE绝缘钢丝钳 200mm
- 工业级自调水泵钳 300mm
- 电工剪 145mm
- 平头电镀内六角组套(加长) 1.5,2,2.5,3,4,5,6,8,10
- 绝缘耐高压活扳手 250mm



家居生活

HOME LIFE

家装/家居维修组套 Home maintenance 23PCS



货号: M07724

- 1件铁皮剪 175mm
- 1件水泵钳 250mm
- 1件羊角锤
- 1件钢丝钳 175mm
- 1件活扳手 200mm
- 1件卷尺 2m
- 1件扁凿
- 1件多功能瓶起子
- 1件镊子
- 1件尖嘴钳 115mm
- 1件电工刀
- 1件数显测电笔
- 1件十字螺丝批 0x75mm
- 1件一字螺丝批 3x75mm
- 1件十字螺丝批 2x100mm
- 1件一字螺丝批 6x100mm
- 1件LED充电手电筒
- 1件美甲剪 6件套

★本产品即将下架, 售完为止

家居礼品豪华组套 Home maintenance 77PCS



货号: M07732

- 1件多功能锤式扳手
- 1件水泵钳
- 1件八合一可换头螺丝批组套
- 1件迷你锯弓
- 1件多功能刮刀
- 10片刮刀刀片
- 1件野营户外刀
- 1件鲁班尺
- 1件铝合金柄美工刀
- 1件多功能户外钳
- 1件数显测电笔
- 1件多功能剪
- 1件强光三档手电筒
- 8件套球头内六角
- 1件带磁羊角锤
- 1件零件收纳盒
- 15支钢钉
- 16支木螺钉
- 5片美工刀刀片

★本产品即将下架, 售完为止

多功能组套 Multifunctional set 3PCS



货号: M07710

- 9合1战术多功能折叠钳1
- 多功能LED战术手电1
- 大开口活扳手1

家居生活

工具书 Reference Book 6PCS



货号: M07755

- 铝合金折叠实用刀1
- 非接触式测电笔1
- 尖嘴钳1
- 十字螺丝批1
- 一字螺丝批1
- 塑柄活扳手1

HOME LIFE

家居厨房精品组套 Kitchenware 7PCS



货号: M07744

- 鸡骨剪 1
- 水果刀 1
- 厨房刀 1
- 切菜刀 1
- 刨皮刀 1
- 磨刀器 1
- 开瓶器 1

家居维修精品组套 Home maintenance 25PCS



货号: M07733

- 美工刀 1
- 测电笔 1
- 厨房剪 1
- 卷尺 1
- 钢丝钳 1
- 羊角锤 1
- 精密螺丝批 16
- 6.3mm系列旋柄 1
- 6.3系列旋具头 1
- 零件 1



货号	页码	货号	页码	货号	页码	货号	页码	货号	页码	货号	页码	货号	页码	货号	页码
M43708	P58	M44627	P56	M47042	P65	M48823	P43	M49306	P67	M51409	P71	M52460	P71	M55220	P106
M43709	P58	M44628	P56	M47043	P65	M48824	P43	M49307	P67	M51410	P71	M52465	P71	M55221	P106
M43710	P58	M44629	P56	M47059	P65	M48825	P43	M49308	P67	M51411	P71	M52470	P71	M55222	P106
M43712	P58	M44630	P56	M47060	P65	M48826	P43	M49309	P67	M51412	P71	M52475	P71	M55226	P105
M43714	P58	M44631	P56	M47061	P65	M48827	P43	M49320	P67	M51413	P71	M52480	P71	M55227	P105
M43716	P58	M44633	P56	M47076	P65	M48828	P43	M49321	P67	M51414	P71	M53336	P70	M55228	P105
M43718	P58	M44661	P57	M47077	P65	M48829	P43	M49322	P67	M51415	P71	M53338	P70	M55229	P105
M44206	P58	M44662	P57	M47078	P65	M48830	P43	M49323	P67	M51416	P71	M53340	P70	M55230	P105
M44208	P58	M44663	P57	M47113	P63	M48831	P43	M49324	P67	M51417	P71	M53341	P70	M55231	P105
M44209	P58	M44664	P57	M47114	P63	M48832	P43	M49325	P67	M51418	P71	M53343	P70	M55232	P105
M44211	P58	M44665	P57	M47115	P63	M48833	P43	M49326	P67	M51419	P71	M53345	P70	M55233	P105
M44212	P58	M44666	P57	M47116	P63	M48834	P43	M49337	P68	M51420	P71	M53346	P70	M55234	P105
M44214	P58	M44667	P57	M47117	P63	M48835	P43	M49338	P68	M51421	P71	M53348	P70	M55235	P105
M44215	P58	M44668	P57	M47129	P63	M48836	P43	M49339	P68	M51422	P71	M53350	P70	M55236	P105
M44217	P58	M44669	P57	M47132	P64	M48838	P43	M49340	P68	M51423	P71	M53352	P70	M55238	P105
M44219	P58	M44670	P57	M47133	P64	M49005	P66	M49341	P68	M51424	P71	M53354	P70	M55239	P105
M44220	P58	M44671	P57	M47134	P64	M49006	P66	M49342	P68	M51425	P71	M53355	P70	M55240	P105
M44222	P58	M44672	P57	M47135	P64	M49007	P66	M49343	P68	M51426	P71	M53357	P70	M55241	P105
M44224	P58	M44673	P57	M47136	P64	M49008	P66	M49344	P68	M51427	P71	M53358	P70	M55242	P105
M44225	P58	M44674	P57	M47137	P64	M49009	P66	M49345	P68	M51428	P71	M53359	P70	M55243	P105
M44227	P58	M44675	P57	M47140	P64	M49010	P66	M49346	P68	M51429	P71	M53360	P70	M55244	P105
M44229	P58	M44678	P57	M47141	P64	M49011	P66	M49347	P68	M51431	P71	M53363	P70	M55245	P105
M44308	P56	M44681	P57	M47142	P64	M49012	P66	M49378	P68	M52317	P70	M53365	P70	M55246	P105
M44309	P56	M44683	P57	M47143	P64	M49023	P66	M49379	P68	M52318	P70	M53370	P70	M55251	P106
M44310	P56	M44711	P58	M47144	P64	M49024	P66	M49380	P68	M52319	P70	M53375	P70	M55252	P106
M44311	P56	M44713	P58	M47146	P64	M49025	P66	M49381	P68	M52320	P70	M53380	P70	M55253	P106
M44312	P56	M44714	P58	M47147	P64	M49026	P66	M49382	P68	M52321	P70	M54059	P72	M55254	P106
M44313	P56	M44715	P58	M47148	P64	M49027	P66	M49383	P68	M52322	P70	M54060	P72	M55255	P106
M44314	P56	M44717	P58	M47149	P64	M49028	P66	M49384	P68	M52323	P70	M54061	P72	M55256	P106
M44315	P56	M44719	P58	M47150	P64	M49039	P66	M49385	P68	M52324	P70	M54062	P72	M55258	P106
M44316	P56	M44721	P58	M47151	P64	M49040	P66	M49386	P68	M52325	P70	M54080	P72	M55259	P106
M44317	P56	M44723	P58	M47152	P64	M49041	P66	M49397	P68	M52326	P70	M54081	P72	M55260	P106
M44318	P56	M44725	P58	M47153	P64	M49052	P66	M49398	P68	M52327	P70	M54083	P72	M55261	P106
M44319	P56	M44727	P58	M47154	P64	M49053	P66	M49399	P68	M52328	P70	M54085	P72	M55262	P106
M44320	P56	M45618	P56	M47155	P64	M49054	P66	M49400	P66	M52329	P70	M54104	P71	M55263	P106
M44321	P56	M45620	P56	M47160	P64	M49065	P66	M49401	P66	M52330	P70	M54105	P71	M55264	P106
M44322	P56	M45622	P56	M47161	P64	M49066	P66	M49402	P66	M52331	P70	M54106	P71	M55265	P106
M44323	P56	M45623	P56	M47173	P64	M49067	P66	M49403	P66	M52332	P70	M54107	P71	M55266	P106
M44324	P56	M45624	P56	M47174	P64	M49120	P66	M49404	P66	M52333	P70	M54108	P71	M55267	P106
M44325	P56	M45625	P56	M47175	P64	M49121	P66	M49405	P66	M52334	P70	M54109	P71	M55268	P106
M44326	P56	M45626	P56	M47185	P65	M49122	P66	M49416	P68	M52335	P70	M54110	P71	M55269	P106
M44327	P56	M45627	P56	M47222	P63	M49123	P66	M49417	P68	M52336	P70	M54111	P71	M55270	P106
M44328	P56	M45628	P56	M47226	P63	M49124	P66	M49418	P68	M52338	P70	M54112	P71	M55271	P106
M44329	P56	M45629	P56	M47232	P63	M49125	P66	M49419	P68	M52340	P70	M54113	P71	M55272	P106
M44330	P56	M45630	P56	M47233	P63	M49126	P66	M49420	P68	M52341	P70	M54114	P71	M55276	P105
M44332	P56	M45631	P56	M47234	P63	M49127	P66	M49421	P68	M52343	P70	M54115	P71	M55277	P105
M44407	P57	M45632	P56	M47235	P63	M49128	P66	M49422	P68	M52345	P70	M54116	P71	M55278	P105
M44408	P57	M45633	P56	M47247	P63	M49129	P66	M50114	P74	M52346	P70	M54117	P71	M55279	P105
M44409	P57	M45634	P56	M47313	P63	M49130	P66	M50119	P74	M52348	P70	M54118	P71	M55280	P105
M44410	P57	M45635	P56	M47372	P136	M49141	P67	M50120	P73	M52350	P70	M54119	P71	M55281	P105
M44411	P57	M45637	P56	M47373	P136	M49142	P67	M50121	P74	M52352	P70	M54120	P71	M55282	P105
M44412	P57	M45639	P56	M47377	P136	M49143	P67	M50125	P74	M52354	P70	M54121	P71	M55283	P105
M44413	P57	M45641	P56	M47378	P136	M49144	P67	M50135	P73	M52355	P70	M54122	P71	M55284	P105
M44414	P57	M45642	P56	M48167	P62	M49145	P67	M50159	P73	M52357	P70	M55032	P107	M55285	P105
M44415	P57	M45643	P56	M48168	P62	M49146	P67	M50821	P73	M52358	P70	M55033	P107	M55286	P105
M44416	P57	M45644	P56	M48172	P62	M49147	P67	M50822	P73	M52359	P70	M55041	P107	M55288	P105
M44417	P57	M45647	P56	M48176	P62	M49158	P67	M50823	P73	M52360	P70	M55051	P107	M55289	P105
M44418	P57	M45649	P56	M48184	P63	M49159	P67	M50824	P73	M52363	P70	M55054	P107	M55290	P105
M44419	P57	M45651	P56	M48191	P65	M49160	P67	M50825	P73	M52365	P70	M55063	P107	M55291	P105
M44420	P57	M45653	P56	M48251	P61	M49161	P67	M50831	P73	M52370	P70	M55064	P107	M55292	P105
M44421	P57	M45656	P56	M48252	P61	M49162	P67	M50832	P73	M52375	P70	M55065	P107	M55293	P105
M44422	P57	M45657	P56	M48253	P61	M49163	P67	M50833	P73	M52380	P70	M55076	P107	M55294	P105
M44423	P57	M45659	P56	M48266	P62	M49164	P67	M51308	P70	M52417	P71	M55093	P107	M55295	P105
M44424	P57	M45661	P56	M48267	P62	M49165	P67	M51309	P70	M52418	P71	M55094	P107	M55296	P105
M44425	P57	M45666	P56	M48268	P62	M49176	P67	M51310	P70	M52419	P71	M55111	P107	M55622	P128
M44426	P57	M45671	P56	M48272	P61	M49177	P67	M51311	P70	M52421	P71	M55114	P107	M55623	P128
M44427	P57	M46636	P57	M48273	P61	M49178	P67	M51312	P70	M52422	P71	M55123	P107	M55624	P128
M44428	P57	M46638	P57	M48274	P61	M49179	P67	M51313	P70	M52423	P71	M55124	P107	M55625	P128
M44429	P57	M46641	P57	M48327	P62	M49190	P66	M51314	P70	M52424	P71	M55125	P107	M55626	P128
M44431	P57	M46646	P57	M48344	P127	M49191	P66	M51315	P70	M52425	P71	M55136	P107	M55630	P128
M44609	P56	M46650	P57	M48345	P127	M49192	P66	M51316	P70	M52426	P71	M55201	P106	M55631	P128
M44610	P56	M46654	P57	M48806	P43	M49193	P66	M51317	P70	M52427	P71	M55202	P106	M55632	P128
M44611	P56	M46655	P57	M48807	P43	M49204	P67	M51318	P70	M52428	P71	M55203	P106	M55636	P128
M44612	P56	M46658	P57	M48808	P43	M49205	P67	M51319	P70	M52430	P71	M55204	P106	M55637	P128
M44613	P56	M46660	P57	M48809	P43	M49206	P67	M51320	P70	M52432	P71	M55205	P106	M55638	P128
M44614	P56	M46663	P57	M48810	P43	M49207	P67	M51321	P70	M52433	P71	M55206	P106	M55639	P128
M44615	P56	M46665	P57	M48811	P43	M49208	P67	M51322	P70	M52434	P71	M55208	P106	M55643	P128
M44616	P56	M46667	P57	M48812	P43	M49209	P67	M51323	P70	M52436	P71	M55209	P106	M55644	P128
M44617	P56	M46670	P57	M48813	P43	M49210	P67	M51324	P70	M52437	P71	M55210	P106	M57301	P107
M44618	P56	M46671	P57	M48814	P43	M49211	P67	M51325	P70	M52441	P71	M55211	P106	M57302	P107
M44619	P56	M46675	P57	M48815	P43	M49212	P67	M51326	P70	M52441	P71	M55212	P106	M57305	P107
M44620	P56	M46677	P57	M48816	P43	M49213	P67	M51327	P70	M52446	P71	M55213	P106	M57307	P107
M44621	P56	M46680	P57	M48817	P43	M49290	P68	M51328	P70	M52446	P71	M55214	P106	M57312	P105
M44622	P56	M47038	P65	M48818	P43	M49291	P68	M51329	P70	M52450	P71	M55215	P106	M57313	P105
M44623	P56	M47039	P65	M48819	P43	M49292	P68	M51330	P70	M52450	P71	M5521			

▶ 终身保用条款

▶ 更换或修理范围

1. 终身保用产品仅限标有终生保用字样的产品，在正常使用过程中，若使用功能有损坏，皆可免费修理，直至更换同一商品。
2. 此项承诺是不受时间限制的。

▶ 非更换或修理范围

1. 产品上无商标的不属于更换或修理范围。
2. 产品在使用后有生锈、电镀层起皮、脱落、表面刮痕、塑料类手柄破损不在更换或修理范围之内。
3. 凡是借助加力杆或者没有锤击功能而用作敲击导致使用功能丧失，均不在保修和更换范围之内。
4. 气动工具、棘轮扳手、带刃口产品均不在保修和更换范围之内（如断线钳、带刃口大力钳、航空剪、胡桃钳、扎线钳、扁凿、铁皮剪等）。
5. 凡属包装材料（如盒子、架子、塑壳、吊卡等），在使用过程中有破损，不在更换或修理范围之内。

▶ 如何修理或更换

使用者在免费修理或更换范围内的产品不需任何凭证，可就近至任何 产品指定销售点填写产品保用卡后，免费修理，直至更换。

免费修理或更换应遵守先修理后调换的原则。

若遇销售点缺货的配件或产品，公司会以邮寄方式送至指定销售点。

非免费维修的产品，指定销售点将提供有偿更换配件的维修服务。

▶ 服务咨询

若您对 产品终身保用条款不了解或在销售点得不到满意的服务时，使用者可以拨打服务热线 400 811 7600 咨询。

▶ Lifetime Warranty Terms

▶ Range of Replacing or Repairing

1. "Lifetime warranty" products are only limited to the products marked with "Lifetime warranty". If the products are functionally damaged in normal use, they can be repaired for free. If they couldn't be repaired, they will be replaced by new products.
2. This promise is without time limit.

▶ Non Replacing or Repairing Range

1. The products without logo
2. Rusting, plating peeling or falling, scratches, or damaged plastic grips
3. The damage because of using the reinforcing bar or using the products without hammering function as hammer
4. The air tools, the ratchet wrenches or the products with the cutting edges (such as bolt cutters, locking pliers with cutting edges, aviation snips, carpenter pincers, tower pincers and chisels, etc)
5. Packaging materials (inner boxes, hanging cards, blister cards)

▶ How to Replace or Repair

The customer can go to any designated distributor of products, fill in the warranty card and then the products will be repaired for free, or replaced.

The products will be repaired first. If they couldn't be fixed, then they will be replaced.

If the distributor doesn't have the spare parts or the same products, Wendeng Maxpower will send them to the distributor by courier.

If the products belong to "Non Replacing or Repairing Range", the distributor will charge the customer the repairing cost.

▶ Service

If the customers don't understand these terms or the customers are not satisfied with the service from the distributors, please call Maxpower's service centre number: 400 811 7600.

▶ 备忘录 Memorandum

Blank memorandum page with horizontal dashed lines for writing.

品牌介绍



工具宣传车



工具展示中心



工具专卖店一角



工具专卖店一角



工具五金科技文化体验馆一角